



Interpreting Assessments of Student Learning in the Introductory Physics Classroom and Laboratory

Citation

Dowd, Jason. 2012. Interpreting Assessments of Student Learning in the Introductory Physics Classroom and Laboratory. Doctoral dissertation, Harvard University.

Permanent link

<http://nrs.harvard.edu/urn-3:HUL.InstRepos:9282889>

Terms of Use

This article was downloaded from Harvard University's DASH repository, and is made available under the terms and conditions applicable to Other Posted Material, as set forth at <http://nrs.harvard.edu/urn-3:HUL.InstRepos:dash.current.terms-of-use#LAA>

Share Your Story

The Harvard community has made this article openly available.
Please share how this access benefits you. [Submit a story](#).

[Accessibility](#)

© 2012 - Jason Edward Dowd

All rights reserved.

Interpreting Assessments of Student Learning in the
Introductory Physics Classroom and Laboratory

Abstract

Assessment is the primary means of feedback between students and instructors. However, to effectively use assessment, the ability to interpret collected information is essential. We present insights into three unique, important avenues of assessment in the physics classroom and laboratory.

First, we examine students' performance on conceptual surveys. The goal of this research project is to better utilize the information collected by instructors when they administer the Force Concept Inventory (FCI) to students as a pre-test and post-test of their conceptual understanding of Newtonian mechanics. We find that ambiguities in the use of the normalized gain, g , may influence comparisons among individual classes. Therefore, we propose using *stratagrams*, graphical summaries of the fraction of students who exhibit "Newtonian thinking," as a clearer, more informative method of both assessing a single class and comparing performance among classes.

Next, we examine students' expressions of confusion when they initially encounter new material. The goal of this research project is to better understand what such confusion actually conveys to instructors about students' performance and engagement. We investigate the relationship between students' self-assessment of their confusion over material and their performance, confidence in reasoning, pre-course self-efficacy and several other measurable characteristics of engagement. We find that students' expressions of confusion are negatively

related to initial performance, confidence and self-efficacy, but positively related to final performance when all factors are considered together.

Finally, we examine students' exhibition of scientific reasoning abilities in the instructional laboratory. The goal of this research project is to explore two inquiry-based curricula, each of which proposes a different degree of scaffolding. Students engage in sequences of these laboratory activities during one semester of an introductory physics course. We find that students who participate in the less scaffolded activities exhibit marginally stronger scientific reasoning abilities in distinct exercises throughout the semester, but exhibit no differences in the final, common exercises. Overall, we find that, although students demonstrate some enhanced scientific reasoning skills, they fail to exhibit or retain even some of the most strongly emphasized skills.

Table of Contents

<i>Title Page</i>	<i>i</i>
<i>Abstract</i>	<i>iii</i>
<i>Table of Contents</i>	<i>v</i>
<i>List of Figures</i>	<i>viii</i>
<i>List of Tables</i>	<i>x</i>
<i>Acknowledgments</i>	<i>xii</i>
Chapter One: Introduction	1
Assessment	2
Theories of Learning	5
Constructivism	6
Conceptual Change	7
Social Constructivism	7
Knowledge in Pieces	9
Constructivism and Inquiry	9
Dissertation Overview	10
Stratagrams for Analysis of FCI Performance	11
Understanding Confusion	12

Exploring “Design” in the Introductory Laboratory	13
Chapter Two: Stratagrams for Assessment of FCI Performance:	
A 12,000-Student Analysis	14
Introduction	15
Background	16
Force Concept Inventory	16
Unidimensionality	17
Normalized Gain	18
Challenges in Normalized Gain	18
Thresholds within the FCI	20
Methods	21
Course Information	22
Measures	22
Sample Description	22
Analytic Methods	23
Analysis	24
Normalized Gain	24
Stratagrams	28
Discussion	32
Limitations	33
Other Alternatives to Normalized Gain	34
Other Conceptual Inventories	36
Conclusion	36
Chapter Three: Understanding Confusion	38
Introduction	39
Background	40
Metacognition	40
Confidence	43
Self-Efficacy	45
Theoretical to Practical	48
Motivation for Analysis	50
Methods – Pilot Analysis	53
Course Information	53
Measures	54
Sample Description	57
Analytic Methods	57
Results – Pilot Analysis	58
Motivation for Full Study	59
Discrepancies between Analyses	59
Limitations of Pilot Analysis	61
Methods – Full Study	62
Course Information	63
Measures	64
Sample Description	69

Analytic Methods	71
Results – Full Study	72
Discussion – Full Study	80
Metacognition, Confidence and Self-Efficacy	82
Changing the System by Measuring	83
Implications for Instruction.....	84
Limitations	85
Future Directions	86
Conclusion	87
Chapter Four: Exploring Design in the Introductory Physics Laboratory.....	88
Introduction	89
Background	89
Learning Goals in the Laboratory	90
Degree of Guidance	92
Transfer	94
Methods.....	98
Course Information	99
Measures	101
Sample Description	106
Analytic Methods	108
Results.....	110
Comparison of Exploratory and Scaffolded Sequences	110
Scientific Reasoning Abilities over Time.....	115
Discussion	122
Comparison of Exploratory and Scaffolded Sequences	122
Scientific Reasoning Abilities over Time.....	124
Transfer.....	125
Limitations	126
Conclusion	127
Chapter Five: Conclusions	129
Review	130
The Goal of Assessment	132
References	134
Appendix A: Reading Exercise Questions	145
Appendix B: Laboratory Activities	196
Appendix C: Laboratory Rubrics	235

List of Figures

2.1	Comparison of different calculations of normalized gain	27
2.2	Comparison of classes with differing $g_{\text{individual}}$ calculations	29
2.3	Comparison of classes with similar $g_{\text{individual}}$ calculations	30
2.4	Comparison of classes with differing student populations	31
3.1	The capillary rise of water in a glass tube	54
3.2	System of two balloons connected by a valve	55
3.3	Fitted linear regression models predicting expression of confusion by selected variables of student learning and engagement	78
3.4	Expression of confusion regressed against reading assignment correctness	79
4.1	Dual sequences of introductory laboratory activities	99
4.2	Students' ability to devise an explanation for an observed pattern	117
4.3	Students' ability to identify assumptions	118
4.4	Students' ability to determine specifically the way in which assumptions might affect the prediction/results	119

4.5	Students' ability to identify sources of experimental uncertainty	120
4.6	Students' ability to evaluate specifically how identified experimental uncertainties may affect the data	121

List of Tables

2.1	Summary of FCI performance and different calculations of normalized gain	24
3.1	Codes used to label student responses to confusion question.....	56
3.2	Proportion of students who respond correctly, by expressions of confusion	58
3.3	Descriptive statistics of characteristics of student learning and engagement, Fall 2010	70
3.4	Descriptive statistics of characteristics of student learning and engagement, Spring 2011	70
3.5	Pairwise correlations of characteristics of student learning and engagement, Fall 2010	72
3.6	Pairwise correlations of characteristics of student learning and engagement, Spring 2011	74
3.7	Fitted linear regression models predicting expression of confusion by selected variables of student learning and engagement, Fall 2010	76
3.8	Fitted linear regression models predicting expression of confusion by selected variables of student learning and engagement, Spring 2011	76
4.1	Scientific reasoning abilities	105

4.2	Descriptive statistics of characteristics of student learning and engagement, Spring 2011	107
4.3	Exhibition of scientific reasoning abilities, Spring 2011	107
4.4	Comparison of exploratory and scaffolded laboratory sequences by characteristics of student learning and engagement.....	111
4.5	Comparison of exploratory and scaffolded sequences by scientific reasoning abilities.....	112
4.6	Comparison of exploratory and scaffolded sequences by laboratory	115

Acknowledgments

I gratefully and humbly acknowledge the many people who have contributed to the work presented here.

I am immensely indebted to my mentors over the years. Geoff Svacha, Jessica Watkins and Julie Schell have been invaluable for the knowledge, insights and friendships they have shared with me. Additionally, Brian Lukoff, Kelly Miller, Laura Tucker and Ives Araujo have played an essential role in these efforts; none of this work would have come as far as it has without their support and guidance. More broadly, each member of the Mazur Group has contributed here by making our community one in which I have felt both motivated and welcome throughout the

years. And, of course, none of this would have been possible without the leadership and support of my advisor, Eric Mazur. Thank you.

More specifically, I would like to thank Kelly, Brian and Nathaniel Lasry for the shared effort that went into the analysis of FCI performance. I would also like to thank Ives, Brian and Eric, in particular, for their contributions to the confusion study. And, regarding the introductory laboratory study, I would like to thank Nils Sorensen and Robert Hart for their help and advice on the practical side of running an instructional laboratory, Rachael Lancor for her thoughtful comments on the work, and Eugenia Etkina for her advice and feedback on virtually every aspect of the research endeavor. I would also like to thank the members of my dissertation committee: Vinny Manoharan, Chris Stubbs and Eric.

The research described here was supported in part by the National Science Foundation under contract DUE-0942044.

Of course, the research itself is only part of the process. For all the rest of it, I am especially grateful to Josh and Tess, without whom I am sure the branch would have snapped from the tree long ago, and Rona and Thomas, without whom I would be homeless. I would like to thank my family, and in particular my mom, for unwavering love and support over these years. And, finally, to my wife, Emma: thank you so much for your patience, your love, and instilling in me the desire to wrap this up – I promise to return the favor in four years.

Chapter One

Introduction

In the study of physics, terms like *energy* have very specific meanings. Instructors often struggle to convey the nuance of these meanings to students, however, because students have already encountered the terms and developed a robust array of associations before entering the classroom. Thus, as physics instructors know quite well, instruction is not merely a matter of introducing the physicist's notion of energy, but rather helping students to merge the new definition with their preexisting associations and to discern the value and validity of these ideas in various contexts.

Just as the concept of energy can surprise students with all the subtle complexities that make it invaluable to physicists, the concept of *assessment* can surprise instructors with its own

complexities. In this work, we detail several efforts to better collect and interpret assessments of student learning in the introductory physics classroom and laboratory.

First, though, we introduce the term *assessment* and provide a central theoretical framework for discussion of these efforts. Ultimately, this introduction allows us to motivate three research investigations presented in detail in the ensuing chapters; we summarize these investigations in Section 1.3.

1.1 Assessment

Simply stated, assessment is the means by which one determines whether learning outcomes have been achieved. In this section, we motivate why assessment is worthy of discussion, introduce the dual purposes of assessment, and describe some aspects of student learning and engagement that instructors may want to assess. We highlight the importance of context, and ultimately pose the question: what do we know about student learning from various assessments that are actually accessible to instructors?

Although sometimes viewed by instructors as being separate from the learning process – the additional “chore” of grading – it is actually the primary means of feedback between students and instructors and therefore integral to the learning process. That is not to say that all graded material is valuable for assessment; indeed, oftentimes the metrics by which success is measured (e.g., exams, standardized tests) are not well aligned with the actual goals of instruction (Wiggins, 2005). In fact, although students are sometimes criticized for being strategic learners (focused on only the evaluated aspects of the course: grades) instead of deep learners (focused on the “real” learning goals), perhaps the real culprit is the gap between learning goals and assessments. When outcomes and assessments are designed together, the distinction between

strategic learners and deep learners vanishes. Thus, with more careful consideration of what is being measured, how it is being measured, and why we should care about it, assessments can play a much more productive role in the physics classroom and laboratory settings.

Assessment is often considered in one of two forms: *formative* and *summative*. Through formative assessment, both the learners and the instructors see how learning is progressing and modify practices accordingly. Examples may include in-class conceptual tests, homework assignments, mid-term exams, and any other activities in which the student work is evaluated before the end of instruction. However, these activities only qualify as formative if the feedback is incorporated into future actions. Graded homework that students discard without a second glance is not formative. Similarly, the act of grading homework and then continuing to instruct in a predetermined way without responding or adapting to the feedback is not formative either. Thus, formative assessment requires some degree of flexibility in the subsequent activities. In contrast, summative assessment involves final judgment of student performance. Final exams are summative. Activities that might have otherwise been formative, if not for the lack of adaptability in the course, are summative. To the extent that even mid-term exams and homework assignments factor into the final grade, these activities are partially summative as well. Neither formative nor summative assessment is inherently better than the other; both play important roles in the classroom.

Of course, assessment is merely the tool – or, more precisely, the act of using a tool – to probe some dimension of student learning or behavior; different tools address different questions of student engagement. So before selecting one kind of assessment over another, we must consider the subject to be assessed. Problem solving abilities and conceptual understanding are two frequent facets of interest in the physics classroom (C. H. Crouch & Mazur, 2001;

McDermott & Shaffer, 1992; Frederick Reif, 1995), but several additional facets may also be important course outcomes. Expectations about physics (Redish, Saul, & Steinberg, 1998) and attitudes towards physics (W. K. Adams et al., 2006) have been assessed and, frequently, do not improve after instruction. Assessments of students' beliefs in their own abilities have been associated with differences in representation in physics (Sawtelle, 2011; Watkins, 2010), indicating the importance of such dimensions of student engagement. We cannot try to optimize a single form of assessment for all of these outcomes; rather, we must consider assessments of each outcome that may differ considerably from one another.

Moreover, as the context in which students learn and undergo assessment varies, performance varies as well. Students' epistemological framing, how they perceive the requirements of the task at hand, factors strongly into their choice of tools, assumptions, and ultimate ability to solve problems (Hammer, 1994; Hammer & Elby, 2003). Students' expectations of homework, along with the varied contexts outside of the class, can influence the nature of homework as an assessment. Thus, the classroom, recitation section, laboratory section and home working environment all afford different opportunities for assessment, and the ways in which they vary from one another can, when interpreted effectively, provide a more complete view of student learning.

Ideally, instructors are able to design and implement assessments that focus on precisely the behavior or abilities that they are trying to engender in students. Rather than assuming that students are reasoning effectively by evaluating performance on homework, the best case would involve instructors directly observing the reasoning process; indeed, in physics education research, video-based discourse analysis and interviews are widely used for that very purpose (Hammer, 1996; Karelina & Etkina, 2007; Lippmann, 2003). However, there are constraints on

what kinds of assessments are available to instructors and how such assessments may be used in a classroom. When classrooms contain as many as several hundred students and instructors must scale any assessment tool by the population of the course, some of the most informative, yet time-consuming, assessments simply are not feasible.¹ In spite of shortcomings, such measures as quantitative homework problems, conceptual questions, and pre/post surveys are very appealing because of how nicely they fit course constraints. Therefore, we pose the question: what can we discover about student learning from various assessments that are actually accessible to instructors? Or, more importantly, what do we *not* know about student learning from such assessments?

1.2 Theories of Learning

We cannot study the assessment of student learning without some discussion of how students learn. Here we introduce several closely related theories of learning that provide a general framework for discussion of each of the projects that follow. Specifically, we introduce the notions that students assemble new knowledge from previous knowledge, that learning results from confronting previously held beliefs that are inadequate, and that learning is socially mediated. Moreover, we introduce a discussion of whether knowledge is better considered as coherent theories or fragmented, abstract pieces that may or may not be employed in different contexts.

We introduce only the most general aspects of these theories here; more specific theoretical frameworks that build on this foundation and incorporate metacognition, self-efficacy and transfer of knowledge between contexts are introduced in subsequent chapters. Because our

¹ Current research efforts into the use of computer vision and automated discourse analysis may make such forms of assessment more accessible in large lecture settings in the future.

research questions are rooted in the pragmatic concerns of instructors – and not the formal aspects of any particular theory – our analysis transects aspects of multiple theoretical frameworks. Therefore, we introduce and discuss each theory, focusing primarily on those elements that best inform our investigation.

1.2.1 Constructivism

Many theoretical models of student learning stem from the study of conceptual change.

Constructivism, the theory that learners build from existing knowledge when they encounter and incorporate new knowledge, provides the foundation for theories of conceptual change.

Individuals' understanding is rooted in their experiences, which are, in turn, strongly influenced by each individual's "cognitive lens" (Confrey, 1990). Although simple, this theory makes the substantial claim that students' pre-existing beliefs and conceptions affect how they encounter new knowledge, even if the new knowledge is not familiar. However, the theory of constructivism does *not* imply that students must formulate ideas from fundamental elements and experiences alone; rather, it implies that students' new ideas, however acquired, connect to previously held ideas.

Piaget significantly elaborated on the theory of constructivism in his studies of developmental cognition in children (Jean Piaget, 1977). He argues that knowledge and learning both are organized into schemas that help us interpret and understand the world. Experiences modify and augment previously existing schemas in process that Piaget describes in three processes: assimilation, accommodation and equilibration. Assimilation is the process of fitting new information into existing schemas; although sometimes such action is appropriate, there is evidence that students assimilate even when objective experience might not allow it, such as

observing what was expected to occur instead of what actually occurred (Gunstone & White, 1981). Accommodation, on the other hand, is the process of changing existing schemas or developing new schemas to incorporate new information. Equilibration is process of balancing assimilation and accommodation. According to Piaget, learning occurs when students' expectations are not met – and they realize expectations are not met – so they must resolve the discrepancy to return to equilibrium. Thus, instructors' roles are to produce confusion and disequilibrium; knowledge that is merely told to students, without producing this disequilibrium, is not learned completely. Piaget believed the stages of learning, which individuals move through the processes described here, are independent of the specific content matter (Jean Piaget, 1977).

1.2.2 Conceptual Change

Posner and colleagues elaborate on Piaget's ideas in his theory of conceptual change, arguing that students will only accommodate new knowledge and change their initial thinking (or “paradigm”) if several conditions are met: dissatisfaction with existing conceptions, intelligible new conceptions, plausible new conceptions and the possibility of a fruitful research program with the new conceptions (Posner et al., 1982). If any of these criteria are not met, the student is unlikely to shift. Instead, they may: reject the anomalous observation, discount the observation as irrelevant, compartmentalize the knowledge to prevent conflicts with existing knowledge or assimilate the new information into existing conceptions.

1.2.3 Social Constructivism

If disequilibrium comes from perturbing students' current schemas and introducing confusion, we must consider contexts in which this might occur. According to Piaget, interactions with

others cause disequilibrium. The introduction of social interactions leads to the theory of social constructivism.

This theory, which is an adaptation of constructivism that differs somewhat from Piaget's characterization, focuses primarily on the process of learning and the interactions of learners with their environment. Vygotsky, who played a prominent role in the development of many important aspects of social constructivism, argued that the dynamics of learning involve interactions (Vygotskiï & Cole, 1978). Such interactions can result in learners moving from one level of understanding to a higher level of understanding, the latter of which is considered to be within one's "zone of proximal development" (ZPD). Vygotsky suggests that one should teach to the limit of the ZPD of the students, but not further (Shayer, 2003).

Although it is tempting to focus upon the differences between these theories – Piaget suggests that learning is an individual's encounter with new knowledge, while Vygotsky suggests that learning is the interaction between an individual and others – the theories are, in fact, very compatible. Vygotsky's notion of spontaneous thinking, or thinking that occurs in the absence of any instruction or external prompting, refers largely to the kind of thinking studied by Piaget, and nonspontaneous thinking, that which is guided by instruction, may follow, move in step with, precede or even advance non-spontaneous thinking (Shayer, 2003). In other words, Vygotsky's theories focus on the dynamics of development while the works of Piaget focus on the statics of development; the latter deliberately remove sources of stimulus that the former explicitly incorporate and assess as potentially good instruction. Although some focus largely on the dichotomy between the individual and the social in these ideas (Lerman, 1996), such a focus confounds the differing research methods and coherent theoretical models (Shayer, 2003).

1.2.4 Knowledge in Pieces

The theories presented here seem to argue implicitly that knowledge is stored as coherent views or understandings that simply may or may not be correct. If one's understandings are not correct, then they are considered misconceptions and must be resolved through the development of a better understanding. The views of both Piaget and Vygotsky are in keeping with this. However, evidence suggests that the notion of individuals' knowledge as coherent and "theory-like" is not in keeping with student behavior (diSessa, 2006). Students may respond correctly to a question in one context and then respond incorrectly to the question in a different context (Redish, 2004). Students base responses upon a variety of resources that may or may not be salient at the time, not upon coherent views of the subject. In diSessa's model, knowledge is made up of smaller, more fragmentary structures that are abstract and may or may not be applied at any time. So students may not differ in their knowledge structures, but rather in the degree of coherence during knowledge construction in different contexts. In spite of describing a fundamentally different conception of knowledge, proponents of these ideas agree with other constructivists in suggesting that students learn through confrontation with conflicting ideas. However, they emphasize that instructors should reinforce the appropriate activation and use of resources in conflicts, rather than the replacement of naïve ideas (Bao & Redish, 2006; diSessa, 2006; Redish, 2004).

1.2.5 Constructivism and Inquiry

In discussing constructivism, social constructivism and related theories of learning, we must also consider the notion of *inquiry*. In science education, "inquiry-based" is generally used to describe activities that encourage students to think like scientists (Barrow, 2006). The notion

stems from Schwab's suggestion that science be taught the same way that science operates (Joseph J. Schwab, 1960; Joseph Jackson Schwab & Brandwein, 1962), an idea that has become a cornerstone of science education in both policy and practice (Barrow, 2006; Bransford, Brown, & Cocking, 2000; Singer, Hilton, Schweingruber, & Vision, 2006). Inquiry is related to theories of constructivism and conceptual change because students who engage in inquiry have much less scaffolding than more traditional forms of instruction; they must actively consider, test and revise their prior knowledge as part of the learning process. Thus, the motivation for inquiry-based approaches to student learning is largely built on the foundations of constructivism.

However, constructivism and inquiry are *not* the same concept. The theory of constructivism may describe "non-inquiry" approaches to instruction in which students have extensive scaffolding that, nonetheless, effectively evokes prior knowledge (McDermott & Shaffer, 2001). Although some researchers highlight the time demands and challenges to working memory posed by inquiry-based instruction (Kirschner, Sweller, & Clark, 2006), extending such objections to the more general notion of constructivism is a mistake.

1.3 Dissertation Overview

These theories leave questions about optimizing learning in the classroom. Should instructors introduce conflict in students' minds to confuse them, provide the scaffolding to further their knowledge through interactions with the instructor and with others, or both? Is there a role for inquiry-based approaches to instruction? Depending on how we interpret these theories, the implications for instruction may vary.

We employ these theories to interpret assessments of student learning and engagement in the classroom and laboratory. In such an empirical approach, research questions and variables

naturally transect and smear the tidy distinctions made in these theories. In the classroom and laboratory settings, students encounter both new and familiar concepts; they work both alone and together, and they both consider and disregard challenges to their pre-existing ideas.

Nonetheless, this is the context in which students encounter physics and instructors must assess such encounters, so it is at the center of this research.

One might argue that the best form of assessment collects as much information as possible about student learning outcomes. However, to effectively use such an assessment, the ability to interpret the information is essential. Here we describe the primary goal of each project in these terms.

1.3.1 Stratagrams for Analysis of FCI Performance

The goal of this research project is to better utilize the information collected by instructors when they administer the Force Concept Inventory (FCI) to students as a pre-test and post-test of their conceptual understanding of Newtonian mechanics. The normalized gain, g , is among the most widely and easily-used metrics because instructors are able to distill the performance of the entire class to a single number. However, the ease and ubiquity of the metric mask several potential ambiguities; through analyzing pre-test/post-test FCI scores of over 12,000 students, we find that these ambiguities can actually influence comparisons among individual classes. Therefore, we propose using *stratagrams*, graphical summaries of the fraction of students who exhibit “Newtonian thinking,” as a clearer, more informative method of both assessing a single class and comparing performance among classes.

In addition to highlighting meaningful changes in student performance between pre-course and post-course surveys, stratagrams also convey information about the pre-course

performance distribution of the student population. Therefore, instructors can use stratagrams to investigate questions related to both conceptual change and social dynamics in the physics classroom.

1.3.2 Understanding Confusion

The goal of this research project is to better understand what students' expressions of confusion actually convey to instructors about their understanding and engagement with the material. Physics instructors typically try to avoid confusing their students. However, the truism underlying this approach, "confusion is bad," has been challenged by educators dating as far back as Socrates, who asked students to question assumptions and wrestle with ideas. This begs the question: how should instructors interpret student expressions of confusion? We evaluate performance on reading exercises while simultaneously measuring students' self-assessment of their confusion over the material. We investigate the relationship between confusion and performance, confidence in reasoning, pre-course self-efficacy and several other measurable characteristics of student engagement. We find that student expressions of confusion are negatively related to initial performance, confidence in reasoning and self-efficacy, but positively related to final performance when all factors are considered simultaneously.

In other words, confusion, a measure of cognitive conflict, is positively related with summative course outcomes, though the relationship is not straightforward. We cannot claim that confusion is *causing* the improved course outcomes; as this is an observational study, we can claim only that we observe the positive relationship. However, the findings are in keeping with theories of constructivism and conceptual change presented here.

1.3.3 Exploring “Design” in the Introductory Laboratory

Mounting evidence suggests that inquiry-based activities in the introductory physics laboratory enhance students’ scientific reasoning skills (Etkina et al., 2006, 2010; Etkina, Karelina, & Ruibal-Villasenor, 2008; Kung, 2005; Lippmann Kung & Linder, 2007; Lippmann, 2003). However, as different approaches propose different degrees of inquiry, one cannot necessarily claim which degree of inquiry is optimal. The goal of this research project is to explore multiple inquiry-based curricula simultaneously. Students engage in two different types of “design-focused” laboratory activities during one semester of an introductory physics course. We find that students who participate in the less scaffolded activities exhibit marginally stronger scientific reasoning abilities in distinct exercises throughout the semester, but exhibit no differences in the final, common exercises. Overall, we find that, although students demonstrate *some* enhanced scientific reasoning skills, they fail to exhibit or retain even some of the most strongly emphasized skills.

Social interactions play an important role in the dynamics of learning in the instructional physics laboratory, and improving instruction ultimately depends on better understanding that role. We elaborate on our findings, explore changes in the exhibition of scientific reasoning skills over the duration of the semester and make several suggestions for introductory laboratory instruction.

Chapter Two

Stratagrams for Assessment of FCI

Performance: A 12,000-student Analysis

The normalized gain, g , is among the most widely and easily-used metrics in physics education research. Although initially used to evaluate the “gain as a fraction of possible gain” of students on the Force Concept Inventory (FCI), g has been used to interpret differences between pre-test and post-test performance on many surveys. However, the ease and ubiquity of the metric mask several potential ambiguities; through analyzing pre-test/post-test FCI scores of over 12,000 students, we find that these ambiguities can actually influence comparisons among individual classes. Specifically, problems may not come to

light when users fail to 1) report standard error values, 2) distinguish between differing means of calculating g and 3) justifiably account for losses (negative gains). Moreover, normalized gain does not tell users which students in the class are improving. Therefore, we propose using “stratagrams,” graphical summaries of the fraction of students who exhibit “Newtonian thinking,” as a clearer, more informative method of both assessing a single class and comparing performance among classes.

2.1 Introduction

Pre- and post-testing is frequently used to assess change over the duration of instruction. For example, surveys of conceptual understanding (Hestenes, Wells, & Swackhamer, 1992; Maloney, O’Kuma, Hieggelke, & Van Heuvelen, 2001), attitudes and expectations about the discipline (W. K. Adams et al., 2006; Redish et al., 1998), beliefs about one’s abilities (Li & Demaree, 2012), and data handling skills (Galloway, Bates, Maynard-Casely, & Slaughter, in press) provide instructors with information about all of these dimensions of student learning and engagement. Although such metrics are relatively coarse – they can only assess that which is contained in the survey, and the survey is only administered twice – they afford instructors a clear tool for assessing change in student performance and comparing different classes to one another.

The ability to compare different classes using such surveys is both an asset and a liability. Comparisons are beneficial when they allow instructors and researchers to assess differences in instructional strategies, communities and time periods using a standardized tool. However, normalized gain may be misleading when instructors make comparisons among just a few classes. In the subsequent sections, we explain precisely how normalized gain can be

misleading, describe various means of assessment in detail and introduce the *stratagram*, a novel tool for evaluating a class and making comparisons.

2.2 Background

In the subsequent sections, we introduce the FCI and discuss various metrics that are widely used to assess student performance on it.

2.2.1 Force Concept Inventory

The FCI was developed to evaluate students' conceptual understanding of Newtonian mechanics (Hestenes et al., 1992). The survey was designed to evoke students' commonsense beliefs about motion and force by strictly avoiding equations and terminology that is strongly suggestive of the physics classroom.

Many questions on the FCI are closely related to questions from the Mechanics Diagnostic Test (MDT) (Antti Savinainen and Philip Scott, 2002; I. A. Halloun & Hestenes, 1985). The MDT was administered in free-response format, and student responses to this version were used to generate multiple-choice responses. Students were also interviewed, and researchers found that interview responses agreed with written responses (I. A. Halloun & Hestenes, 1985). Moreover, results from multiple-choice versions agreed with results from free-response versions, justifying the use of the former.

In contrast to the MDT, the FCI provides a more complete profile of students' misconceptions (Hestenes et al., 1992). Although the same extensive procedure for developing the MDT was not carried out for the FCI, student interviews were still carried out to explore the various reasons for incorrect responses. Non-Newtonian choices by Newtonian thinkers were

very rare, though Newtonian responses for non-Newtonian reasons were more common, so the authors suggest that the FCI be treated as an upper bound on students' Newtonian understanding.

Although the original version of the FCI contained only 29 questions, the current version, modified in 1995, contains 30 questions.

2.2.2 Unidimensionality

Use of any single metric to summarize FCI performance implies that the test is unidimensional, which means that each question addresses the same underlying construct; in such a case, any shortcomings of one question are washed out by asking more questions, and each additional question in the test increases one's confidence in the measurement. If the test is not unidimensional, one must be careful about drawing conclusions from a student's overall score. If responding correctly to the first item, for instance, indicates specific knowledge, responding correctly twice on a that item during pre-testing and post-testing is not equivalent to responding incorrectly on the post-test and gaining on the second item. One can calculate both gain, normalized with respect to possible gain, and loss, normalized with respect to possible loss, as separate values (Dellwo, 2010), although this does not resolve the question of unidimensionality.

There have been several extended discussions about whether the FCI is unidimensional (I. Halloun & Hestenes, 1996; P. Heller, 1995; Hestenes & Halloun, 1995; Huffman & Heller, 1995). Factor analysis lends support to the notion that the FCI is unidimensional. (Wang & Bao, 2010) Some suggest that qualitative analysis of student responses to FCI-related content justify dividing the survey into subsets that probe related mental models, even if factor analysis does not bring such distinctions to light (Bao & Redish, 2006).²

² We will discuss Model Analysis, the alternative approach to analyzing FCI performance mentioned here, in subsequent sections.

Without attempting to resolve the debate, we note that gain statistics are only meaningful given the assumption of unidimensionality, so we make this assumption in our analysis, building on the work of others (Bao, 2006; R. R Hake, 1998; Marx & Cummings, 2007).

2.2.3 Normalized Gain

Administration of a single conceptual survey to groups of students at the beginning (pre-test) and end (post-test) of the semester is often used to assess the efficacy of different classroom interventions, and the most widely-used means of summarizing results is to report the normalized gain:

$$g = \frac{post - pre}{post_{\max} - pre}, \quad (2.1)$$

where *pre* is the pre-test score, *post* is the post-test score and *post*_{max} is the maximum possible post-test score. As explained below, these scores may be individuals' scores or average scores, depending on which variant of the calculation is employed. This metric was effectively used to conduct a large-scale analysis of the impact of interactive engagement on student performance in the FCI (R. R Hake, 1998).

2.2.4 Challenges in Normalized Gain

Although normalized gain was introduced and justified explicitly within the scope of a 62-course study of the effectiveness of interactive teaching, others have used normalized gain in comparisons involving only a few groups of students (Cheng, Thacker, Cardenas, & Crouch, 2004; C. H. Crouch & Mazur, 2001; Finkelstein & Pollock, 2005; R. R Hake, 2002; R. R Hake, Wakeland, Bhattacharyya, & Sirochman, 1994; Kost, Pollock, & Finkelstein, 2009; N. Lasry, 2008; Nathaniel Lasry, Mazur, & Watkins, 2008; Lorenzo, Crouch, & Mazur, 2006; MacIsaac &

Falconer, 2002; McKagan, Perkins, & Wieman, 2007; Meltzer, 2002; Meltzer & Manivannan, 2002; Pollock, Finkelstein, & Kost, 2007). Such uses of the normalized gain can be problematic when those employing the metric do not 1) justifiably account for losses (negative gains), 2) distinguish between different means of calculating g and 3) report standard error values.³

When students' final scores are less than their initial scores, the normalized gain is essentially an unbounded negative number (Marx & Cummings, 2007). Moreover, unlike the fraction “gain” over “possible gain,” the fraction “loss” over “possible gain” – which is g when the pre-test score is greater than the post-test score – lacks meaningful interpretation. An alternative definition of normalized gain, coined *normalized change*, addresses these points:

$$g_{change} = \begin{cases} \frac{post - pre}{post_{max} - pre} & pre < post, \\ \frac{post - pre}{pre} & pre > post. \end{cases} \quad (2.2)$$

Although this calculation avoids the fraction “loss” over “possible gain,” the inclusion of “loss” over “possible loss” with “gain” over “possible gain” raises the question: how should one interpret an average of the two different expressions presented in Equation 2.2? The suggestion that users normalize loss with respect to possible loss creates problems when users ultimately must average students' normalized losses and normalized gains together; because the two values result from separate calculations, the average merges two separate characteristics (normalized gain and normalized loss) of students in the class. So even though some issues are addressed with this calculation, other issues are raised.

³ Many of the references cited here actually avoid some of these problems; I highlight them not as “bad” examples, but rather as noteworthy examples of studies involving comparisons among small numbers of classes.

There is another ambiguity in normalized gain: differences from alternate calculation methods that seem equally reasonable (Bao, 2006; R. R Hake, 1998). One may calculate individual normalized gains for each student and then average them,

$$g_{individual} = \left\langle \frac{post - pre}{post_{max} - pre} \right\rangle, \quad (2.3)$$

or one may calculate average pre-test scores and post-test scores before evaluating a class-wide normalized gain,

$$g_{class} = \frac{\langle post \rangle - \langle pre \rangle}{post_{max} - \langle pre \rangle}. \quad (2.4)$$

The two forms are used interchangeably, and they have been reported to be within 5% of one another when the class consists of more than 19 students (R. R Hake, 1998). These variations are not random, though; theoretical analysis indicates that the two calculations can differ depending on whether high-performing or low-performing students are improving the most (Bao, 2006).

Although $g_{individual}$ readily allows for calculation of standard error, g_{class} does not. One can compute the standard error of the latter when it is assumed to be small (R. R Hake, 1998), but such margins are not always reported (C. H. Crouch & Mazur, 2001; Cummings, Marx, Thornton, & Kuhl, 1999; Knight & Wood, 2005; Kost et al., 2009; Lorenzo et al., 2006). When only a few classes are compared, margins of error can strongly affect the interpretation of results.

2.2.5 Thresholds within the FCI

The ambiguities described above can make the interpretation of g very challenging. Furthermore, the particular interpretation of the FCI intended by the authors of the survey presents another challenge to using g to evaluate class performance; the authors indicate that the FCI is a means of identifying *confirmed Newtonian thinkers* (Hestenes & Halloun, 1995). Specifically, they

assert that a score above 85% is evidence of a Newtonian understanding of the concept of force. A score below 85% and above 60% reflects a less coherent Newtonian concept of force, and a score below 65% reflects a largely non-Newtonian concept of force. If the FCI score of student A rises from 10/30 to 20/30 from pre-test to post-test and the score of student B rises from 22/30 to 26/30, then both students have normalized gains of 0.5 but only student B has crossed the threshold into Newtonian thinking.

This threshold is not intended to be a perfect discriminator of Newtonian thinking in contexts outside of the FCI; indeed, others have found that high performance on the test does not necessarily correspond with high performance on other measures (Mahajan, 2005), and the authors themselves note that the test should be treated as an upper bound of students' conceptual understanding (Hestenes et al., 1992). However, because the use of FCI pre-tests and post-tests has become such a widely-used means of measuring conceptual change in physics, we explicitly focus on this context in our discussion of to make such Newtonian transitions clearer.

2.3 Methods

These different avenues of calculation and analysis generate several questions. What fraction of students exhibits *net* loss from pre-test to post-test? If only students with net losses complicate normalized gain, do their scores substantially affect the average value? Even though g_{class} and $g_{individual}$ may differ in theory, does the use of different forms of g affect the interpretations of comparisons between classes? Do margins of error affect comparisons?

To address these questions, we compiled and analyzed pre-test and post-test FCI scores from thousands of students at several institutions.

2.3.1 Course Information

The FCI was administered at the beginning and end of instruction to students enrolled in introductory physics courses, and we collected these scores from instructors and researchers at five different institutions: one large U.S. public research university, one large U.S. private research university, one private U.S. liberal arts college, one Canadian community college and one large Canadian public research university. Only students who completed both the pre- and post-test were included in analysis. The data was collected from classes taught between 1995 and 2010.

We know the approximate level of instruction of all of the courses, but we do not have any specific information about the teaching methods employed, student backgrounds or participation rates. Therefore, our work here is not intended to make any assertions about the relationships between any of these factors and FCI performance; rather, our aim is to investigate and demonstrate how to make most effectively the kinds of comparisons that one might otherwise make using g .

2.3.2 Measures

The single measure of performance analyzed in this study was the FCI. We collected item-level pre-test and post-test information, although only total scores are required for graphical analysis and the different calculations of normalized gain.

2.3.3 Sample Description

Altogether, data of 12,087 students from 36 classes were compiled and analyzed. We tried as much as possible to group students by instructor/section. In some cases, the “class” in the data

set is actually an amalgamation of several different sections of a single course, where a different instructor taught each section. In other cases, the “class” in the data set is a single section of a course, where another section of the same course, taught by a different faculty member, is considered a separate class.

2.3.4 Analytic Methods

The primary methods used here include calculation and comparison of the various forms of normalized gain detailed above.

Constructing Stratagrams

We propose a novel graphical representation of student performance on the FCI that displays the rate at which students transition to, or continue to exhibit, Newtonian thinking. Stratagrams highlight each of these rates for a given class. Moreover, they: (1) address relevant losses in a natural, readily interpretable way, (2) easily permit calculation of standard error values, and (3) highlight, rather than mask, differences in pre-test performance that may inform comparisons.

Stratagrams are bar graphs in which the width of each bar reflects the pre-test performance of students in the class and the height of each bar reflects the rate of success in student post-test performance. Specifically, the width of each bar reflects the fraction of the class that is initially below 60% (non-Newtonian), 60-85% (pre-Newtonian), and above 85% (Newtonian); low-performing classes have a wide non-Newtonian bar, for example, and high-performing classes have a wide Newtonian bar. The height of each bar reflects the fraction of students that achieves Newtonian post-test scores; the height of the non-Newtonian bar, for example, conveys the

fraction of students who scored below 60% on the pre-test and scored above 85% on the post-test. The standard error of the height of these bars reflects the uncertainty in the fraction.

One can think of a stratagram as being similar to a scatterplot of post-test performance against pre-test performance, as the two dimensions are of interest in both cases. However, in stratagrams, the information is binned and filtered so that the relevant features are most salient.

2.4 Analysis

In the following sections, we detail our analysis of pairwise comparisons among classes using normalized gain as the metric of interest, and then using stratagrams.

2.4.1 Normalized Gain

Table 2.1 details the pre-test, post-test and normalized gains – determined using each of the three calculations described above – for each of the 36 classes in our data set.

Table 2.1: Summary of FCI performance by different calculations of normalized gain.

ID	N	<i>pre</i>	s.e.	<i>post</i>	s.e.	<i>g_{class}</i>	s.e.	<i>g_{individual}</i>	s.e.	<i>g_{change}</i>	s.e.
1	794	7.58	0.13	15.41	0.25	0.349	0.017	0.362	0.010	0.350	0.011
2	381	8.05	0.19	16.68	0.37	0.393	0.028	0.412	0.015	0.403	0.016
3	114	10.49	0.46	18.42	0.64	0.406	0.057	0.430	0.029	0.426	0.030
4	1375	7.01	0.08	13.64	0.17	0.288	0.010	0.295	0.007	0.281	0.007
5	932	8.05	0.13	18.42	0.22	0.473	0.020	0.488	0.009	0.485	0.009
6	156	12.22	0.47	20.29	0.53	0.454	0.056	0.458	0.027	0.457	0.027
7	1004	7.08	0.10	14.48	0.19	0.323	0.012	0.327	0.008	0.319	0.008

Table 2.1 (continued)

ID	N	<i>pre</i>	s.e.	<i>post</i>	s.e.	<i>g_{class}</i>	s.e.	<i>g_{individual}</i>	s.e.	<i>g_{change}</i>	s.e.
8	915	7.58	0.11	16.39	0.22	0.393	0.016	0.403	0.009	0.396	0.010
9	169	12.95	0.46	19.97	0.50	0.412	0.053	0.414	0.026	0.418	0.025
10	1083	7.26	0.09	14.63	0.18	0.324	0.012	0.327	0.008	0.318	0.008
11	848	8.22	0.12	18.35	0.22	0.465	0.019	0.479	0.009	0.476	0.010
12	186	14.58	0.49	21.46	0.39	0.446	0.049	0.391	0.027	0.407	0.024
13	814	7.08	0.11	14.43	0.23	0.321	0.015	0.329	0.009	0.318	0.010
14	1039	8.15	0.11	16.49	0.21	0.382	0.016	0.394	0.009	0.387	0.009
15	191	12.30	0.39	20.04	0.44	0.437	0.046	0.442	0.023	0.448	0.022
16	30	9.10	0.65	18.53	0.97	0.451	0.086	0.462	0.041	0.461	0.041
17	75	22.84	0.65	25.17	0.47	0.326	0.115	0.245	0.064	0.334	0.043
18	59	25.00	0.62	25.75	0.63	0.149	0.181	0.139	0.106	0.301	0.053
19	70	24.63	0.62	26.16	0.58	0.285	0.173	0.235	0.099	0.402	0.050
20	27	21.41	1.40	22.89	1.18	0.172	0.214	0.046	0.182	0.250	0.078
21	73	24.14	0.60	26.37	0.48	0.381	0.146	0.297	0.082	0.441	0.045
22	63	18.81	0.92	23.59	0.65	0.427	0.112	0.394	0.060	0.453	0.043
23	56	18.61	0.91	23.48	0.74	0.428	0.123	0.358	0.076	0.455	0.044
24	70	18.01	0.78	22.50	0.72	0.374	0.104	0.392	0.059	0.417	0.041
25	103	15.99	0.57	20.16	0.58	0.297	0.065	0.283	0.041	0.318	0.031
26	115	15.69	0.58	21.84	0.45	0.430	0.059	0.426	0.027	0.430	0.024
27	113	16.48	0.66	22.59	0.52	0.452	0.075	0.465	0.027	0.466	0.026
28	162	15.06	0.50	22.14	0.37	0.474	0.050	0.432	0.030	0.459	0.022
29	540	17.79	0.27	19.53	0.31	0.143	0.035	0.038	0.054	0.199	0.017
30	78	17.29	0.75	21.19	0.74	0.307	0.093	0.285	0.052	0.335	0.036

Table 2.1 (continued)

ID	N	<i>pre</i>	s.e.	<i>post</i>	s.e.	<i>g_{class}</i>	s.e.	<i>g_{individual}</i>	s.e.	<i>g_{change}</i>	s.e.
31	32	11.47	0.93	20.38	0.90	0.481	0.097	0.501	0.038	0.501	0.038
32	26	9.85	0.70	18.62	1.11	0.435	0.100	0.430	0.058	0.426	0.060
33	183	20.43	0.41	26.40	0.26	0.624	0.073	0.612	0.027	0.634	0.021
34	158	20.39	0.47	26.80	0.26	0.667	0.082	0.676	0.023	0.686	0.020
35	32	7.53	0.60	10.94	0.74	0.152	0.045	0.147	0.031	0.129	0.037
36	21	10.33	1.10	18.24	1.28	0.402	0.114	0.427	0.055	0.424	0.056

Among the 36 classes in our data set, the correlation between $g_{individual}$ and g_{class} is 0.96, which is similar to the previously reported value (R. R Hake, 1998). Such a large correlation indicates that the two calculations convey similar information about the population. However, the two values, when calculated for a single class, differ by more than 5% of g_{class} in 36% of the classes. In other words, the large correlation in the population does not necessarily mean that the two values are certain or even highly likely to agree for any particular class.

We find that, when we compare all 36 individual classes to one another, only 24% of these pairwise comparisons are consistent and statistically significant no matter which variations of normalized gain – g_{class} , $g_{individual}$ or g_{change} – are used. Even when we limit comparisons to pairs that differ by an absolute margin of greater than 0.1 in at least one of the variants of normalized gain, only 35% of them are consistent and statistically significant. In other words, even comparisons that appear to be relatively large are not robust across all metrics in almost two thirds of the cases. Moreover, 58% of all comparisons that are statistically significantly different

at the 0.05-level according to at least one variant of normalized gain are *not* statistically significantly different according to another.

The fluctuations between different calculations of normalized gain are not surprising when we consider the effect of loss. We find that, on average, approximately 9% of the students in a class exhibit *net* loss from pre-test to post-test; this percentage varies with average pre-test score, as higher-performing classes tend to exhibit greater net loss than lower-performing classes.

Figure 2.1 highlights the effect of losses on normalized gain by narrowing the focus to three classes.

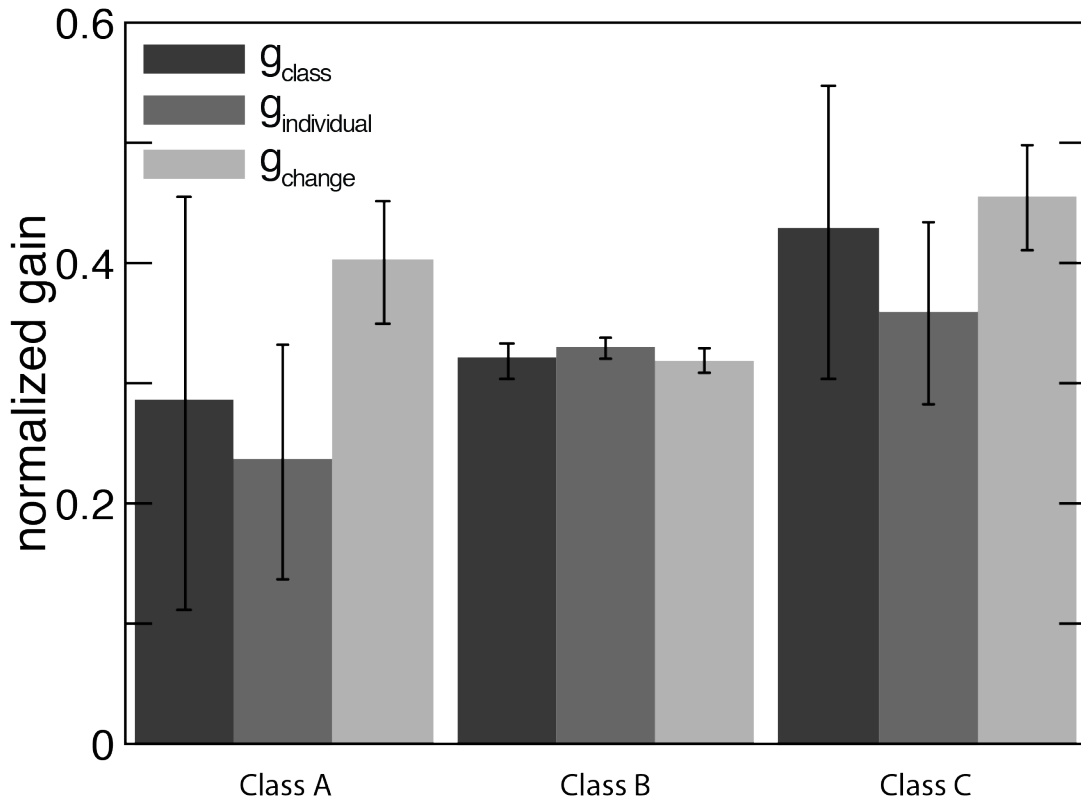

Figure 2.1: Comparison of different calculations of normalized gain. The normalized gain calculated using average pre-test and post-test scores is g_{class} , the gain calculated by taking the average of individual gains is $g_{individual}$ and the gain calculated according to (Marx & Cummings, 2007) is g_{change} . Alternative calculations of g alter the relationships among the classes, and the inclusion of standard errors reveals that many of the comparisons are not actually statistically significant.

First considering g_{class} without error bars (a more common practice with g_{class} than with other calculations), Class “C” exhibits the strongest normalized gain and Class “A” exhibits the weakest normalized gain. However, the inclusion of standard error makes virtually any comparison using g_{class} ambiguous, and alternative calculations alter the relationships among the classes.

Overall, the fact that, on average, 9% of students exhibit loss suggests that Figure 2.1 is not merely an exception to the general trend, but rather an exemplar of what happens when comparisons are made among a small number of classes. In lieu of attempting to make assertions about which definition of normalized gain is best, we introduce a novel representation of pre-test and post-test performance that more easily allows for one-to-one comparisons.

2.4.2 Stratagrams

Because the goal of using stratagrams is to assess the fraction of students who exhibit Newtonian thinking, gains and losses that do not result in crossing the Newtonian threshold do not affect the stratagram; losses that cross the threshold of Newtonian thinking are reflected in the height of that bar. Thus, stratagrams address loss in a natural way, and effectively disregard losses that do not relate to the goal of the metric. The examples below elucidate the applications of these plots.

In Figure 2.2, we highlight two classes with different $g_{individual}$. The histograms show that students in the class on the bottom exhibit higher post-test scores, but they do not convey information about which students – low-performing, high-performing, etc. – improved. The stratagrams, on the other hand, not only show what fraction of the class exhibits Newtonian thinking on the post-test, but they show that improved scores among initially pre-Newtonian

students set the two classes apart. In other words, stratagrams convey more specific information about which students in the class achieve meaningful gains.

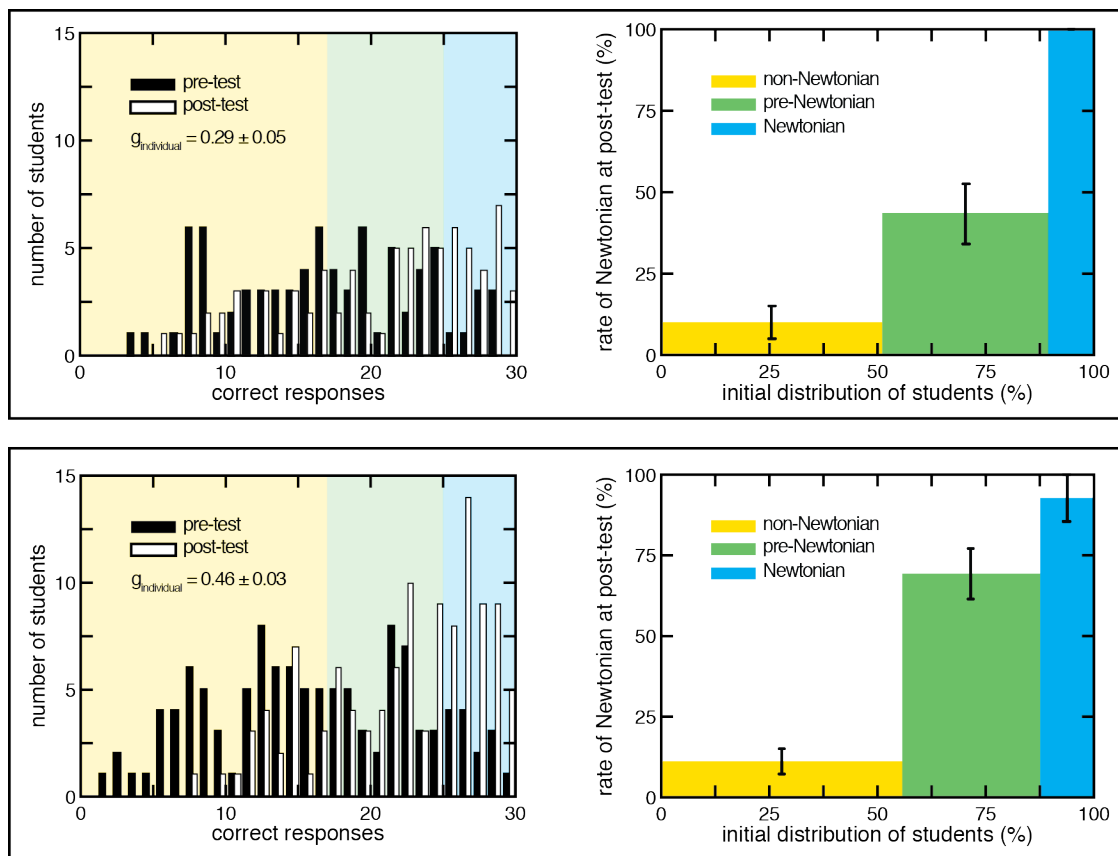

Figure 2.2: Comparison of classes with differing $g_{individual}$ calculations. FCI histograms (left) and stratagrams (right) are shown for two different classes with different normalized gains. The shaded regions of the histograms highlight those pre-test scores that compose the corresponding bars in the stratagrams. In the class on the top, $g_{individual}$ is 0.29 ± 0.05 , g_{class} is 0.31 ± 0.09 and g_{change} is 0.33 ± 0.04 . In the class on the bottom, $g_{individual}$ is 0.46 ± 0.03 , g_{class} is 0.45 ± 0.08 and g_{change} is 0.47 ± 0.03 . The histograms show that students in the class on the bottom exhibit higher post-test scores, but they do not convey information about which students improved. The stratagrams, on the other hand, convey more specific information about which students in the class achieve meaningful gains.

In Figure 2.3, we highlight two classes with virtually identical values of $g_{individual}$. The histograms suggest that more students are doing well on the post-test in the class on the bottom. Stratagrams reveal that (1) students with non-Newtonian pre-test scores, who compose the

majority of both classes, tend to perform slightly better in the class on the bottom, and (2) the fraction of students with Newtonian pre-test scores who do not remain Newtonian on the post-test is also higher on the bottom. In other words, the two identical normalized gain values result from gains and losses from different groups of students in each class, and only the stratagrams highlight those differences. In this way, stratagrams naturally address the relevant losses without distorting the gains of other students.

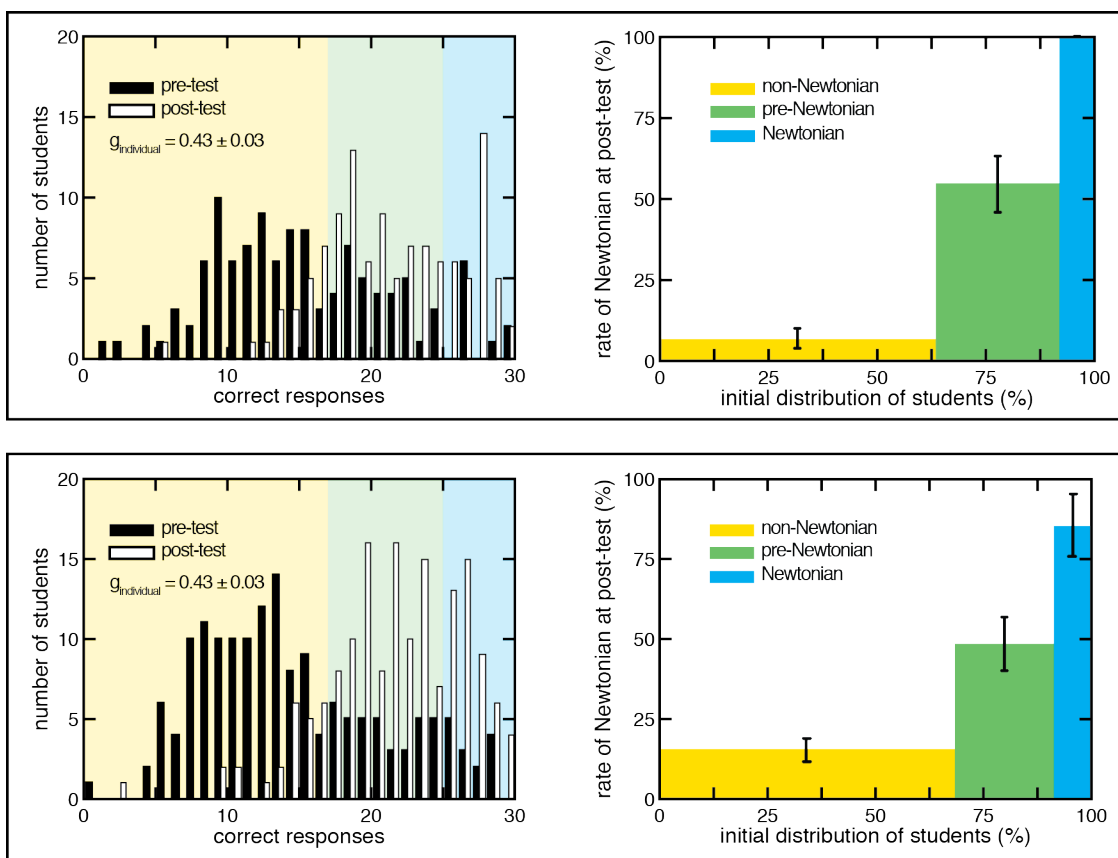

Figure 2.3: Comparison of classes with similar $g_{individual}$ calculations. FCI histograms (left) and stratagrams (right) are shown for two different classes with similar normalized gains. The shaded regions of the histograms highlight those pre-test scores that compose the corresponding bars in the stratagrams. In the class on top, $g_{individual}$ is 0.43 ± 0.03 , g_{class} is 0.43 ± 0.02 and g_{change} is 0.43 ± 0.06 . In the class on bottom, $g_{individual}$ is 0.43 ± 0.03 , g_{class} is 0.46 ± 0.02 and g_{change} is 0.47 ± 0.05 . The histograms suggest that more students are doing well on the post-test in the class on the bottom. The stratagrams reveal that the normalized gain values have different origins in each class.

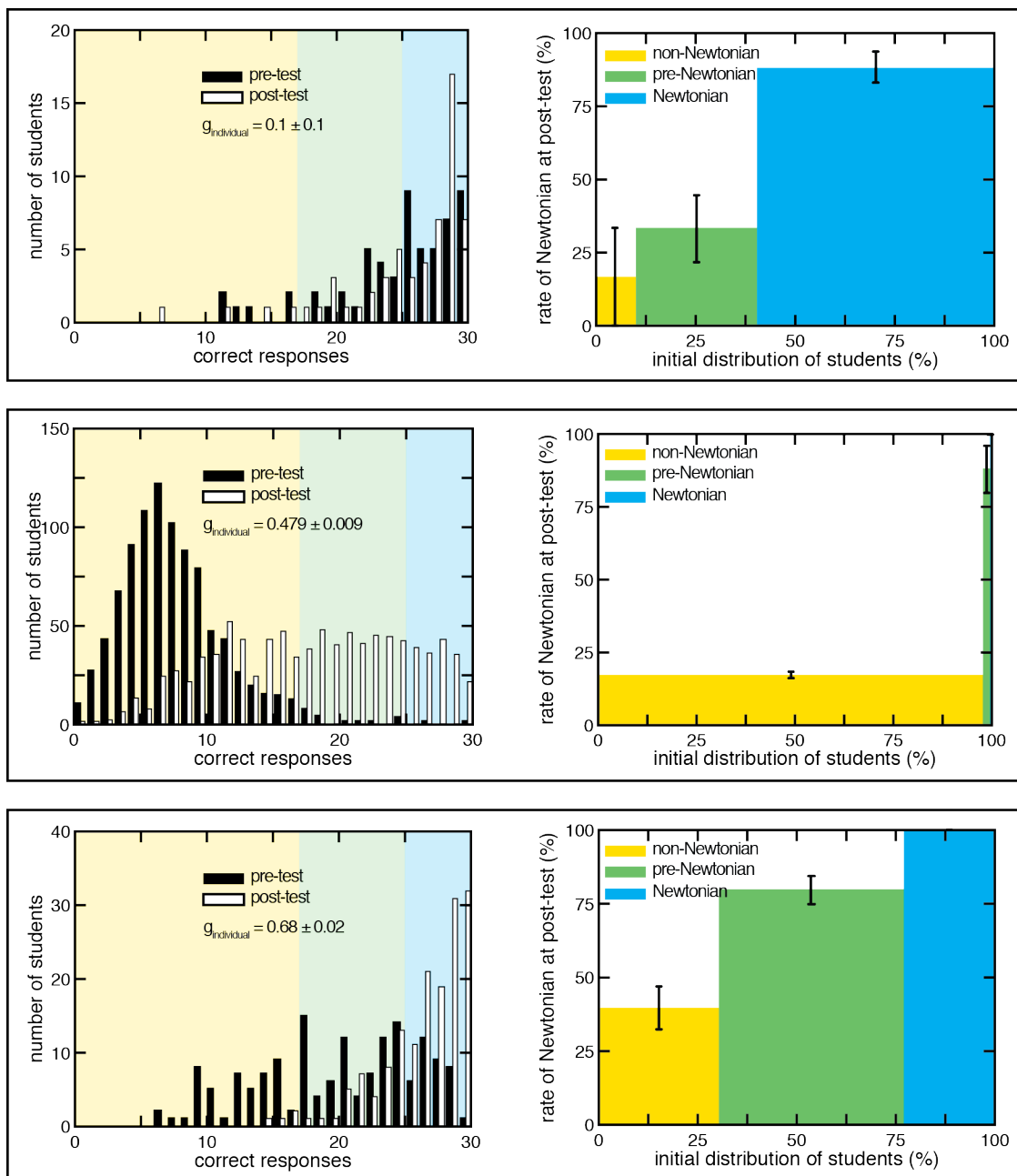

Figure 2.4: Comparison of classes with differing student populations. FCI histograms (left) and stratagrams (right) are shown for three different classes with different student populations. The shaded regions of the histograms highlight those pre-test scores that compose the corresponding bars in the stratagrams. In the class on top, $g_{individual}$ is 0.1 ± 0.1 , g_{class} is 0.1 ± 0.2 and g_{change} is 0.30 ± 0.05 . In the class in the middle, $g_{individual}$ is 0.479 ± 0.009 , g_{class} is 0.47 ± 0.02 and g_{change} is 0.48 ± 0.01 . In the class on bottom, $g_{individual}$ is 0.68 ± 0.02 , g_{class} is 0.69 ± 0.02 and g_{change} is 0.67 ± 0.08 . These three classes have very different student populations that are masked by normalized gain values, but the stratagrams highlight the population differences.

Finally, in Figure 2.4, we show three classes with very different student populations and normalized gain values. The histograms show that the student populations of these three classes are not the same—indeed, the distribution of students in two of the three classes are skewed by the test ceiling—but the values of $g_{individual}$ mask all of those differences. The stratagrams, however, reveal differences in the student population that might affect performance. These differences are important because students with higher pretest scores tend to exhibit a higher degree of loss. Additionally, normalized gain values may, in fact, vary with pre-test score (Coletta & Phillips, 2005). Thus, stratagrams enable users to easily make comparisons between classes with very different student populations.

2.5 Discussion

The analysis presented here draws a sharp distinction between studies involving many classes and studies involving only a few classes. The large correlations between g_{class} and $g_{individual}$ support the notion that these definitions are interchangeable when the number of classes under consideration is large. However, as demonstrated by our pairwise analysis, using different calculations of g can significantly impact the interpretation of any given comparison between two classes.

We have already detailed several specific benefits of using stratagrams for pairwise comparisons among classes. In this section, we discuss some limitations of our analysis and describe this work in relation to other efforts to study and improve our understanding of student performance on concept inventories like the FCI.

2.5.1 Limitations

Stratagrams have many benefits as a basis of comparison among classes, but they do not convey all information about a class. The plots suppress the total number of students in the class, and instead represent them as fractions of the whole, primarily to simplify the plot and suppress extraneous details. However, this is not to suggest that class size does not matter when two classes are being compared. We also suppress the number of students who transition from non-Newtonian to pre-Newtonian levels of performance both to simplify the plot and to emphasize that the goal of an introductory mechanics course is to acquire a coherent Newtonian force concept, so improvement in performance that falls short of that goal is of less interest when comparing classes.

Others have noted that the authors of the FCI provide no concrete evidence for the thresholds they put forward (Antti Savinainen and Philip Scott, 2002; Dancy, 2000), and that students who performed well on the FCI do not necessarily exhibit Newtonian thinking in other contexts (Mahajan, 2005). Additionally, as shown in our analysis, some students exhibit Newtonian thinking on the pre-test and then fail to exhibit it on the post-test. In other words, the FCI, albeit often much more insightful than final exams and other course performance metrics, is not a perfect discriminator of Newtonian thinking. Performance on the FCI cannot necessarily be generalized to other contexts, and performance on the FCI, like other tests, is subject to variation. No single test will capture student understanding. Nonetheless, instructors actually *use* the FCI, so it is important that we are able to interpret student responses as effectively as possible.

2.5.2 Other Alternatives to Normalized Gain

Model Analysis is a detailed graphical and numerical alternative to the normalized gain (Bao & Redish, 2006). The approach involves consideration of alternate mental models that students may employ on subsets of the FCI, as well as consideration of the notion that students can hold multiple mental models and use any one of them, perhaps inconsistently, with some probability on any given item. Model Analysis involves the calculation of density matrices to determine probabilities, and it also hinges on qualitative investigations of student reasoning to establish the mental models in play.

Another alternative means of assessing FCI performance involves item response theory (IRT), in which students' total scores establish their ability level and the fraction of students who respond correctly on each item (as a function of ability level) is used to determine the difficulty, likelihood of guessing and degree of discrimination achieved by each item (Wang & Bao, 2010). With separate populations of students, IRT does not readily allow instructors to compare different courses to one another. However, if populations are pooled together so that ability levels of students from different classes are on the same scale, then the average ability level of a class or the shift in average ability level of a class can be used to compare multiple classes.

A similar tool for investigating questions is the analysis of item response *curves* (IRC) (Morris et al., 2006). These curves represent a less rigorous alternative to IRT; they permit item-level analysis of trends in both correct and incorrect responses without use of the assumptions and statistical methods of IRT. In the case of IRC, students' performances represent their ability levels. Although the simplicity of this approach may be appealing, the average student performance for a given class is no different than simply averaging those students' scores. Thus,

although the insights about various items on the FCI may be informative, IRC does not provide more insight into comparisons among classes.

Finally, one might also consider comparing the effect size of the change in performance among different classes (L. Deslauriers, E. Schelew, and C. Wieman, 2011). This approach is more statistically rigorous than normalized gain as a means of comparing the difference between two distributions, though problems may still arise when classes are either high-performing or low-performing, in which cases the skewed distributions may diminish the validity of effect size as a basis of comparison.

There are strengths to all of these methods. Model Analysis allows for very detailed analysis of the progression of student reasoning through FCI assessment, but the method is somewhat complicated and requires qualitative interview analysis to establish anticipated mental models. IRT and IRC analyses are largely focused on investigating the survey itself, though IRT allows for calculation of different kinds of gain (ability level rather than performance) that does not encounter the challenges of loss and ceiling effects that hinder normalized gain. Effect size captures the same phenomenon, too, but none of these methods convey the same information as stratagrams. Stratagrams are unique in that they allow for comparisons between classes but do not mask the differences that may exist. Furthermore, they convey information about student performance on an absolute scale. Ultimately, we believe that all of these approaches have clear merit and distinct goals, and therefore complement one another in revealing the most from student performance on the FCI.

2.5.3 Other Conceptual Inventories

All of our analysis and discussion has focused on the FCI. Stratagrams are tailored to the FCI in order to more strongly motivate the arguments presented here, but one can use a generalized version of stratagrams to analyze any conceptual inventory in which scores can be binned according to level of performance. The different groups into which scores are divided (non-Newtonian, pre-Newtonian and Newtonian, in the case of the FCI) must be consistent across classes under comparison, but the specific thresholds may not be so important. If the survey is designed without a specific threshold for success, then one can modify the stratagram as follows: rather than the height of each bar representing the fraction of students who cross a threshold, the height can correspond to the average post-test score for the sub-set of students within that particular pre-test group or bin. Such a plot conveys the same information as the calculation of non-normalized gain, but with the addition of separating students by initial performance and highlighting the initial-performance distribution of the class.

2.6 Conclusion

Stratagrams are simple visualizations of student performance that highlight the rate of students becoming Newtonian thinkers, and therefore provide a clear, informative basis for both assessing a single class and comparing performance among a small number of classes. Normalized gain is certainly useful when *many* different classes are involved; the large correlations among the three differing means of calculating g support this claim. However, data show that several factors, particularly losses and differences in pre-test performance, complicate the interpretation of normalized gain when it is used to compare FCI performance between small numbers of classes. In such comparisons, fluctuations among different calculations of normalized gain are not

negligible and can significantly affect the outcome. Moreover, none of the variations of normalized gain address the fact that users of normalized gain cannot say which students in the class are improving, and none of them highlight differences in student population. Thus, stratagrams fill an instructive, accessible and previously unexplored niche in the array of tools that are available to instructors for learning the most from student performance on pre-test and post-test conceptual inventories like the FCI.

Chapter Three

Understanding Confusion

Physics instructors typically try to avoid confusing their students. However, educators have challenged the truism, "confusion is bad," dating as far back as Socrates, who asked students to question assumptions and wrestle with ideas. So, is confusion good or bad? How should instructors interpret student expressions of confusion?

During two semesters of introductory physics that involved Just-in-Time Teaching (JiTT) and research-based reading materials, we evaluate performance on reading assignments while simultaneously measuring students' self-assessment of their confusion over the material. We examine the relationship between confusion and performance, confidence in reasoning, pre-course self-efficacy and several other measurable characteristics of student engagement. We find

that student expressions of confusion are negatively related to initial performance, confidence in reasoning and self-efficacy, but positively related to final performance when all factors are considered simultaneously.

3.1 Introduction

When posing the question, “Is anyone confused?” the instructor is implicitly asking students to engage in the act of monitoring their own understanding, or *metacognition* (Flavell, 1979).

Students must think about the material, consider with which parts they feel very comfortable and with which parts they struggle, and then report their findings back to the instructor. Despite how simple the question seems, a breakdown anywhere along the series of steps that students undertake in responding may cause the student to reply in a misleading way. This notion may be familiar to instructors who pose such questions before a quiz, address any confusion (if students even pose questions), but find that students do not perform very well on the quiz at all.

Of course, students’ minds are not the only places where such “confusion” assessments can fail. Even if students respond by considering their understanding and posing any questions that arise, instructors may not interpret such feedback from their students constructively. Students’ questions and expressions of doubt may indicate discomfort with the material, and that more time and activities should be devoted to addressing these questions. On the other hand, questions and expressions of doubt may indicate that students are actually engaged and growing familiar enough with the material that it is conflicting with their prior knowledge and expectations. Student recognition of this disequilibrium may assist, rather than inhibit, the learning process (J. Piaget, 1985; J. Piaget, Green, Ford, & Flamer, 1971; Jean Piaget, 1977). If this is the case, instructional efforts could shift to questions that students have yet to ask themselves. In other

words, we cannot yet say whether confusion indicates that things are going poorly or at that things are going well.

Our primary research question is, “How do students’ expressions of confusion relate to other measures of learning and engagement?” We acknowledge that expressions of confusion are not the same as students’ internal confusion, and we also acknowledge that confusion may convey many things, both good and bad. From a practical point of view, the question posed is fairly straightforward. However, from a theoretical point of view, as we shall see in the subsequent section, the variable *confusion* transects several different theoretical domains. We explore these domains, present our results, and then analyze our findings in light of both practical and theoretical concerns.

3.2 Background

The study of metacognition, monitoring one’s own understanding, plays an important role in addressing our research question. Additionally, the study of confidence and the study of self-efficacy, belief in one’s ability to perform a skill or do something, shed light on the sometimes-surprising student responses (or lack of responses) to instructor-posed questions of confusion. Thus, we introduce these three concepts as an integrated theoretical framework for this study – metacognition, confidence and self-efficacy – by emphasizing their links to each other and to our primary research question.

3.2.1 Metacognition

There are two primary aspects of metacognition: (1) knowledge and beliefs about cognitive phenomena and (2) the regulation and control of cognitive actions (Garofalo & Lester, 1985;

Resnick, 1976). The former aspect includes beliefs about oneself and others, knowledge of the requirements of the task at hand and awareness of strategies and their usefulness for carrying out certain tasks. The latter aspect is focused on the application of such knowledge and beliefs to the action of carrying out a cognitive task or problem. Expressing confusion, for example, implies that one has knowledge of such cognitive phenomena and can regulate (i.e., identify shortcomings) one's abilities.

Metacognition is important to the process of learning for the following reason (Everson & Tobias, 1998):

The learner usually has to master a great deal of new knowledge in a limited amount of time. Moreover, learning in classrooms or other structured training environments is often dynamic, with knowledge and information being updated frequently. Clearly, those who accurately distinguish between what they have already mastered and what is yet to be learned have an advantage in these situations, since they can be more strategic and effective learners. (p. 66)

Everson and Tobias assess metacognition, or knowledge monitoring ability (KMA), by evaluating the difference between students' estimates of their knowledge and their performance. They find that this ability is, in general, positively related to GPA, though in some groups the relationship was not very strong or statistically significant (Everson & Tobias, 1998). Questions of validity arise when students are expected to be consistent with one another in how they self-report about their thinking, as individuals may vary in the weight they assign different criteria or the manner in which they use the scale (Ward, Gruppen, & Regehr, 2002).

In an effort to promote metacognition in science education, Schraw and colleagues discuss the concept of *self-regulated learning*, our ability to understand and control our own learning environments (Schraw, Crippen, & Hartley, 2006). This concept is rooted in social-cognitive learning theory, in which learning results from personal, environmental and behavioral factors (Bandura, 1977). In this model, individuals advance through levels of development that focus on

external, social standards (observation, followed by imitation) to levels that depend upon internal standards (self-control, followed by self-regulation). When an individual is self-regulatory, the learning process involves three main components: cognition, metacognition and motivation.

Rickey and Stacy connect the discussion of whether students' questions and statements are cognitive or metacognitive to the question of whether students' knowledge is consistent or fragmented (Rickey & Stacy, 2000). They argue that more metacognitive students are more likely to recognize inconsistencies and refine naïve ideas. Specifically regarding physics, Koch emphasizes that a student must understand every word, not just most of them, in a physics textbook in order to understand the content without misconceptions, because physics text and content is very different from other texts that students encounter (Koch, 2001). Koch observes that adding metacognitive tasks to reading-comprehension exercises results in higher post-test scores when compared to a group of subjects who do not complete the metacognitive tasks, and therefore argues that metacognition and self-regulation of thinking during reading is an essential part of reading comprehension. Enhanced reading comprehension helps students monitor their reading level by themselves and wean themselves away from dependence on teacher evaluation (Koch, 2001).

More generally, research on involving strong and weak readers, writers and problem solvers shows skilled, successful individuals also tend to be more successful in metacognitive activities (Sinkavich, 1995). Kruger and Dunning describe several studies in which they find that individuals who perform poorly do not know how poorly they are performing (Kruger & Dunning, 1999). The researchers attribute individuals' the lack of awareness of the extent of poor performance to links between content knowledge and the metacognitive skills related to that knowledge.

Several of these studies embed their own explanations of the role of metacognition in language of “misconceptions” and “naïve ideas.” However, as described in Chapter One, the suggestion that students’ knowledge is coherent and robust – even if incorrect – is not well-supported by recent studies (diSessa, 2006). Changes in context and shifts in the manner in which students frame the activity can alter what they appear to “know” (Redish, 2004). Therefore, as we consider the role of metacognition and metacognitive activities in student learning, we must not neglect other theories that we draw upon in our explanations.

3.2.2 Confidence

Confidence refers to one’s belief in one’s own ability to act in a proper or effective way (Merriam-Webster, Inc, 2003). Researchers have investigated “metamemory” and metacognition by investigating the relationship between student confidence and performance. Sinkavich reports a positive correlation between confidence and correctness on an examination, and also notes that better performing students are more able to accurately predict what they do and do not know (Sinkavich, 1995). In the experiment, which involves an examination, students are given several “replacement questions” that can be included for grading instead of questions in which students’ confidence is particularly low; students are required to make this decision and choose the questions to be replaced themselves. Thus, one can assess whether students have a good sense of which questions they do not know. In spite of the positive relationship between confidence and correctness, correct students are not always confident about their correct answers (Sinkavich, 1995). To explain these observations in a theoretical context, Sinkavich employs the expression “feeling of knowing” (FOK) (Hart, 1965), as a proxy for the first of the two primary aspects of metacognition: knowledge and beliefs about cognitive phenomena. Interestingly, in comparing

good students and poor students, the relationship between confidence and correctness is much stronger with good students, whereas poor students' correctness does not vary much with confidence. In other words, good students appear to be better able to monitor their performance. In the replacement task, however, both good and poor students exhibited comparable ability to determine which questions should be dropped from the examination.

Similar studies elaborate on the relationship between confidence and performance.

Engelbrecht and colleagues reports a positive relationship, and also reports that students are more confident in conceptual math problems than procedural math problems, even though there are no performance differences on the two types of problems (Engelbrecht, Harding, & Potgieter, 2005). Shaughnessy also reports a positive correlation between confidence and correctness and notes a larger degree of overconfidence among lower-performing subjects (Shaughnessy, 1979). Dunning and colleagues suggest that (1) relatively difficult tasks tend to yield overconfidence more often than relatively easy tasks, and (2) high levels of confidence are usually associated with high levels of overconfidence (Dunning, Griffin, Milojkovic, & Ross, 1990).

Through consideration of the manner in which data is analyzed, we can better understand these observations. If item difficulty is determined by calculating percentage of subjects who respond to that item correctly, but merely choosing an answer implies that confidence is at least 50% (assuming two choices), then the confidence cannot match correctness unless subjects are irrationally choosing the response they believe is less likely to be correct. In other words, overconfidence is statistically more likely to increase with difficulty. To further explain other facets of the overconfidence effect, Gigerenzer and colleagues put forward a theory of probabilistic mental models (PMM) (Gigerenzer, Hoffrage, & Kleinbölting, 1991). In contrast to cognitive bias research that claims that people are naturally prone to making mistakes in

reasoning and memory, their model assumes that people are good judges of the reliability of their knowledge. They hypothesize that individuals generalize specific questions to broader categories, situations or contexts and then inductively infer the correct result with some probability of correctness. Moreover, they propose that item-by-item overconfidence results from the fact that one may be fairly knowledgeable about each item in a survey but difficult or tricky items tend to be surprising, so the average correctness is always likely to be lower than the average confidence. On the other hand, when asked how many items were answered correctly, Gigerenzer and colleagues suggest that subjects are likely to *underestimate* in their response, as long as the questions are representative of environmental occurrence and not selected to be particularly tricky. They present empirical data to support this theory (Gigerenzer et al., 1991). These findings are not necessarily at odds with other studies (Kruger & Dunning, 1999), as the former do not address variations in estimations from students at different performance levels.

3.2.3 Self-Efficacy

According to social-cognitive learning theory, the learning process involves three main components: cognition, metacognition and motivation (Bandura, 1977). Schraw and colleagues identify self-efficacy and epistemological beliefs as the two subcomponents of motivation in this theoretical framework (Schraw et al., 2006). Simply put, self-efficacy refers “people’s judgments of their capabilities to organize and execute courses of action required to attain designated types of performance” (Bandura, 1986, p. 391). Although this may seem exactly the same as confidence – and, indeed, confidence is sometimes used as a measure of self-efficacy – there are distinct differences between the two constructs.

Albert Bandura introduced the term *self-efficacy* to provide a means of explaining the effect of performance-based procedures on psychological change, particularly involving cases of individuals with acute phobias (Bandura, 1977). He emphasizes the importance of experiences of mastery and effective performance in ultimately changing cognitive processes, with the goal of establishing a connection between the cognitive structures in individuals' minds and their actions. It is not sufficient that an individual believe that certain actions or behaviors will have specific outcomes; if the individual does not believe in his/her ability to perform such actions, then the individual does not associate the outcomes with himself/herself.

According to self-efficacy theory, in the case of a person with an acute phobia, simply seeing an action performed by another (e.g., handling a snake), or even modeling that action, may not resolve the phobia in the individual if the exercise does not change the individual's belief in his/her ability to perform the same action. In the classroom, self-efficacy theory suggests that students may see a task performed (and even imitate or model that execution) but not actually change their beliefs about their ability to perform such tasks in general and therefore ultimately fail to exhibit learning (Andrew, 1998; Lent, Brown, & Larkin, 1984; Multon, Brown, & Lent, 1991; Pietsch, Walker, & Chapman, 2003).

To be specific about the process, Bandura distinguishes between *outcome expectancy* – a person's belief that a certain behavior will lead to certain outcomes – and *efficacy expectation* – a person's belief that he/she can successfully execute the behavior required to produce the outcomes (Bandura, 1977). If a situation appears to an individual to exceed his/her own ability to cope with it, the individual tends to avoid that situation or does not persist very long in the efforts. On the other hand, when people believe they can do something, they tend to be more persistent at achieving the desired goal or behavior; they locate and enact resources to aid them.

Bandura refers to the ability to exercise this control over thought and action as *human agency* (Bandura, 1989).

Efficacy expectations have magnitude, generality and strength; these characteristics influence performance and are, in turn, altered by the cumulative effects of one's efforts (Bandura, 1977). Performance accomplishments, one of four primary means of probing and augmenting an individual's self-efficacy, bear the most relevance to the activities in a physics classroom and instructional laboratory; students cannot merely observe certain practices, but must engage in the activities themselves. Similarly, the other formal means of assessing self-efficacy – vicarious experience, verbal persuasion and emotional arousal – link to analogous activities in physics learning environments. Prolonged encounters are more successful than distributed encounters in effecting change.

Self-efficacy is a broad-reaching theoretical subject that encompasses many elements of learning and development. Research efforts in physics education indicate that “physics self-efficacy” plays an important role in both learning and interest in the discipline (Fencil & Scheel, 2004; Sawtelle, 2011). More broadly, Multon and colleagues perform a meta-analysis of data collected from many studies and find a positive relationship between self-efficacy and academic performance in the sciences (Multon et al., 1991). This relationship is even stronger between performance and post-course self-efficacy in studies that distinguished between pre- and post-course surveys of self-efficacy. In another study, Andrew measures self-efficacy through evaluations of confidence in various criteria contained within the Self-Efficacy for Science (SEFS) survey and finds that self-efficacy for sciences is positively related to academic performance (Andrew, 1998). This study does not account for changes in self-efficacy. Interestingly, no relationship between expressions of self-efficacy and science background is

observed. Lent and colleagues find that self-efficacy compares favorably to other models for academic success and career decision-making (Lent, Brown, & Larkin, 1987). Additionally, the perceived importance of self-efficacy beliefs may be stronger for women in male-oriented domains than for individuals operating in traditional settings (Zeldin & Pajares, 2000), and differences in self-efficacy are associated with differences in gender performance and representation (Kost et al., 2009; Sawtelle, 2011).

Researchers distinguish among more general beliefs about competence (self-concept), attitudes regarding one's beliefs (self-esteem) and self-efficacy (Linnenbrink & Pintrich, 2003; Pietsch et al., 2003). Self-efficacy associates behavioral, cognitive and motivational engagement with learning. Linnenbrink and Pintrich suggest that, ideally, one's self-efficacy is a bit beyond one's ability so that, in attempting to complete tasks, one's skills are likely to increase; this suggestion is connected to the notion of "zone of proximal development" (Vygotskiï & Cole, 1978), discussed in Chapter One. Overall, the study suggests that self-efficacy is positively related to adaptive motivational beliefs and positive affective reactions, and negatively related to negative emotions.

3.2.4 Theoretical to Practical

Several researchers highlight practical implications of the largely theoretical discussion presented here. To improve student learning outcomes, instructors should engage in inquiry-based activities, build collaboration among students, provide multiple strategies for accomplishing goals, emphasize the role of mental models in conceptual change, and build from students' and instructors' epistemological beliefs (Schraw et al., 2006). All of these suggestions are motivated by the links between self-efficacy, confidence, metacognition and student learning

outcomes. If one considers problem solving as grappling with unfamiliar tasks and methods that are not well-understood (Schoenfeld, 1992), as opposed to the completion of tasks using prescribed methods, metacognition plays a much more important role (Rickey & Stacy, 2000).

These studies highlight the importance of self-efficacy in the classroom, but they do not necessarily shed light on the differences between self-efficacy, confidence and, the construct that is ultimately of the most interest to us, confusion. We have no formal reason to believe that measures of confidence and self-efficacy are distinct; perhaps a student's expression of confidence is simply indistinguishable from a student's expression of self-efficacy in that same ability. Some argue that self-efficacy is very specific to a task in a given situation while the term self-concept, described above, actually applies to more general beliefs about competence (Linnenbrink & Pintrich, 2003). In contrast, others refer to self-efficacy as a more general sense of one's ability (e.g., in science), and even Bandura mentions that performance accomplishments in multiple contexts can effectively improve self-efficacy across contexts (Bandura, 1977). Thus, the lines between self-concept and self-efficacy, or confidence in one's ability and confidence in one's actions in a specific circumstance, are not entirely clear from the vocabulary employed in the theoretical frameworks. Nomenclature aside, we can say that the distinction in meaning between general and specific conceptions of ability and performance exists.

The concept of confusion, from a theoretical viewpoint, is even more muddled. Expressions of confusion blend cognitive and metacognitive aspects of students' knowledge, as well as elements of self-efficacy and confidence at both specific and general scales. Consequently, we cannot say, a priori, how expressions of confusion interact with such theoretical components; rather, we explore a series of studies in which data relating confusion, confidence and self-efficacy are collected simultaneously. Ultimately, we have some basis for discussing confusion

in the context of the theories presented here, as well as a means of answering the question of practical importance to instructors: How do students' expressions of confusion relate to other measures of learning and engagement?

3.2.5 Motivation for Analysis

We propose to investigate student expressions of confusion in a sequence of studies that are closely motivated by an initial study involving similar research questions (C. Crouch, 2000). The data were collected during courses using two specific instructional strategies, Just-in-Time Teaching and Peer Instruction

Just-in-Time Teaching

Just-in-Time Teaching (JiTT) is a teaching and learning strategy composed primarily of Internet-based, pre-class activities and corresponding in-class activities (Novak, Gavrin, & Wolfgang, 1999). Students engage with the material – e.g., complete a reading assignment, watch an Internet-based video, interact with a simulation – and then complete a “WarmUp” activity the evening before class. The students' submissions provide feedback to the instructor before class, so the instructor has the opportunity to use the class time to focus on student difficulties. These pre-class activities may consist a brief essay question, an estimation question and a multiple-choice question – the combination prescribed by Novak and colleagues – or some other combination of questions.

By shifting the transmission of information from inside the classroom to outside, instructors are no longer required to “cover” all of the material in class. Rather, they can engage students in a variety of activities and focus upon only the particularly difficult facets of the material. JiTT

developers suggest a combination of in-class activities that includes discussion of student responses to pre-class exercises, interactive activities and demonstrations.

Peer Instruction

Peer Instruction (PI) is a research-based, interactive teaching strategy that facilitates student interaction and, specifically, metacognition, in the classroom (Mazur, 1997). Instead of lecturing, the instructor presents conceptual questions to the students. According to Mazur, “this process a) forces students to think through the arguments being developed and b) provides them (as well as the teacher) with a way to assess their understanding of the concept” (Mazur, 1997, p. 10). Each conceptual question is preceded by a brief presentation of the material and follows this general format:

- (1) the instructor poses the question,
- (2) students are given approximately one to three minutes to think about it,
- (3) students respond individually,
- (4) students try to defend and convince neighboring students of their responses,
- (5) students respond individually once again,
- (6) and the instructor explains the correct response.

Students may respond using clickers, flashcards or fingers, all of which are equally effective (N. Lasry, 2008). This strategy provides a stream of feedback on how the students are responding to the material, and it allows students to communicate ideas and consider multiple perspectives.

Researchers consistently associate PI with improved learning outcomes (C. H. Crouch & Mazur, 2001; Smith et al., 2009).

Like the in-class activities associated with JiTT, PI requires that students encounter the material before coming to class. Accordingly, the pre-class reading assignments associated with JiTT provide the same feedback to instructors using PI as they provide to instructors using JiTT alone; in both cases, student responses shape the subsequent in-class activities. In incorporating the pre-class components of JiTT to PI, Mazur makes one important modification. Instead of the combination of three questions proposed by Novak and colleagues, he suggests that instructors ask two content-related questions and one “confusion” question. The confusion question requires students to reflect on their understanding of the material, and therefore captures a fundamentally different, unique facet of student engagement.

In subsequent sections, we will detail this feedback question, how it may be posed to students, and how instructors may best interpret student responses.

Crouch and Mazur (2000)

In their original analysis (C. Crouch, 2000), Crouch and Mazur posed the question, “Does a lack of confusion indicate understanding?” To investigate this question, they analyzed a single reading exercise, containing three questions, that was submitted by 151 students. They found that students who expressed confusion about topics related to the questions appeared to respond correctly to the content-related questions more than students who did not express such confusion. However, this original analysis was not intended to be a rigorous evaluation, and therefore required further analysis before moving on to a full study.

3.3 Methods – Pilot Analysis

In order to investigate the results from previous work and better assess our ability to answer the primary research question, we first reexamine the data collected and analyzed by Crouch and Mazur. In this pilot analysis, we addressed the following research question: What is the relationship between students' performance on the content-related questions and their expressions of confusion?

In the subsequent full study, we apply the insights from the pilot analysis toward a much larger question involving many more reading exercises and several additional measures of student learning and engagement.

3.3.1 Course Information

We analyzed data collected from an introductory physics course at Harvard University during the fall of 1998. This was the first-semester course in a one-year sequence for non-physics concentrators. The instructor employed PI and the pre-class components of JiTT. Students received credit for participation in, but not correctness of, their responses to both pre-class and in-class questions.

Importantly, in this course, pre-class reading assignments included only free-response questions. The two content-related questions were intended to be thought-provoking and counterintuitive, so students would have to critically engage with the material before class. Questions required students to explain their reasoning. In each assignment, the confusion question was posed after the two content-related questions.

Students submitted responses online using the *Interactive Learning Toolkit* (ILT), a course management platform developed for use with PI and JiTT.

3.3.2 Measures

In the pilot study, we analyzed two facets of a single pre-class reading exercise: student performance on each of the content-related questions and student expressions of confusion.

For this assignment, students were required to read Chapter 15 of *General Physics* (Sternheim & Kane, 1991). In the chapter, the authors detail the principles and mathematics that describe surface tension, capillarity, and Laplace's law. The subsequent reading exercise consisted of the following questions, posed in this sequence:

- (1) Consider the capillary rise of liquid in a glass tube (shown in Figure 3.1). How does the pressure at point P at the surface of the liquid compare to the pressure at point Q of equal height?

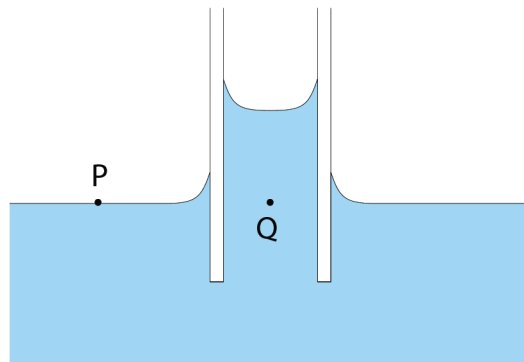

Figure 3.1: The capillary rise of water in a glass tube.

- (2) Two identical balloons are connected to a tube (shown in Figure 3.2). Balloon B is inflated more than balloon A. Which way does the air flow when valve P is opened?

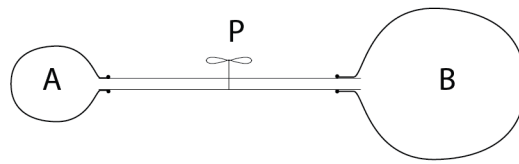

Figure 3.2: System of two balloons connected by a valve.

- (3) Please tell us briefly what points of the reading you found most difficult or confusing. If you did not find any part of it difficult or confusing, please tell us what parts you found most interesting.

Students responded to these questions in free-response, short-essay form. Although this format provides students flexibility in their responses, it allows them to submit correct answers with incorrect justifications, “incorrect” answers with well-reasoned justifications, and a plethora of other ambiguous responses. We could have labeled responses “completely correct” or “not completely correct,” but then correct responses without justification, of which there are many, could alter the apparent relationship between performance and expression of confusion.

Therefore, instead of subjectively making judgments and labeling responses as “correct” or “incorrect,” we labeled responses descriptively, according to the outcome stated by the student (e.g., in question (2), labels included “flows to the left,” “flows to the right,” and “does not flow”).

We employed a similar descriptive approach in labeling student expressions of confusion. As detailed in Table 3.1, we coded responses as relating to the textbook (explanation provided,

figures, equations, examples, symbols, problems and terminology), concepts (laminar flow, cohesive forces, surface tension, contact angle, capillarity, Laplace’s law, pressure), the reading exercise itself (question one and question two), general goals and “real world” applications, which means the response relates to connecting the formal content to actual practices. Different concepts are associated with different sections of the text: Sections 15.1 and 15.2 relate to the concepts of contact angle, surface tension and capillarity; Section 15.3 relates to the concept of Laplace’s law; and later sections relate to other, more applied concepts. A single response may require multiple labels.

Table 3.1: Codes used to label student responses to confusion question.

textual	section	conceptual	section	other	section
explanation	any	laminar flow	14	question 1	15.1 and 15.2
figures	any	cohesive forces	15.1	question 2	15.3
equations	any	surface tension	15.1	objectives	any
examples	any	contact angle	15.2	applications	15.2 or 15.4
symbols	any	capillarity	15.2	not confused	none
problems	any	Laplace’s law	15.3		
terminology	any	pressure	15		

By coding expressions of confusion this way, we are able to sort the responses according to several different criteria: textual vs. conceptual, confusion vs. no confusion, and question-related confusion vs. non-question-related confusion. There are no statistically significant differences in the proportion of students who respond with the correct answer between groups that express text-related confusion and concept-related confusion. Thus, we collapse these codes together and

focus on the content areas to which the expressions of confusion relate. Because students were asked to identify only the points they were *most* confused about, we cannot assume that they were exhaustive in their responses.

To summarize, students were sorted based only upon these two facets of their responses: the answer provided to each of the content questions and the explicit sources of confusion identified.

3.3.3 Sample Description

The sample consists of 151 students. As we have access to only the responses of these students to this pre-class reading exercise, we cannot comment on the relationships among additional factors (e.g., pre-course knowledge, final grades). Overall, 43 students (28%) responded with the correct answer to the first content-related question, 37 students (25%) responded with the correct answer to the second content-related question and 16 students (11%) responded with the correct answers to both content-related questions. 62 students (41%) expressed confusion related to the first content-related question, 47 students (31%) expressed confusion related to the second content-related question, and 39 students (26%) expressed no confusion.

3.3.4 Analytic Methods

To investigate the differences in performance between groups of students who express confusion about different parts of the reading, we performed chi-squared tests to determine whether there is an association between the confusion and correctness classifications. This test permits comparisons between multiple groups. If only two groups are under comparison (i.e., a 2×2 table), the z test for comparing proportions between two groups can also be used, though both tests yield precisely the same result (Moore, McCabe, Duckworth, & Alwan, 2008).

Two researchers independently coded students' free responses to reading exercise questions and subsequently discussed coding. All discrepancies were resolved during discussion, and the coding criteria were refined to eliminate future discrepancies. Once the criteria for each code were sufficiently well established through discussion, remaining reports were coded independently.

3.4 Results – Pilot Analysis

We compare the proportion of students who responded to *each* question correctly (i.e., identified the outcome that we consider “correct”) between groups that express confusion about different aspects of the reading assignment. Specifically, we made comparisons among students who express no confusion, students who express confusion unrelated to the question under consideration, and students who express confusion related to the question under consideration.

Table 3.2: Proportion of students who respond correctly, by expressions of confusion.

Question	no confusion	non-Q-related confusion	Q-related confusion	chi-square <i>p</i> value
1	36% (N = 39)	30% (N = 50)	23% (N = 62)	0.338
2	13% (N = 39)	23% (N = 65)	36% (N = 47)	0.041

As shown in Table 3.2, we find no statistically significant relationships between expressions of confusion and correctness on the first (capillarity) content-related question. Although there are apparent numerical differences, they are not statistically significant. On the contrary, we do find a statistically significant relationship between expressions of confusion and correctness on the

second content-related question. In this case, the proportion of students who respond with the correct answer is higher among students who express confusion than among those who express no confusion, and highest among those who express confusion related to the question.

3.5 Motivation for Full Study

One might argue that only *some* students who are performing well express confusion because they are critically engaging with the material; other students may have such a strong grasp of the material that they perform well without any confusion. Similarly, some poorly performing students may not know how little they know, while others are so confused that they perform poorly and can only ask questions. The existence of these different groups within the population could explain the results presented here.

The data analyzed here were previously studied and presented to motivate the notion that expressions of confusion may actually be associated with positive course outcomes (C. Crouch, 2000). However, the results presented here differ from those previously presented; we find that only one of the two questions exhibits a positive relationship between expressions of confusion and performance, whereas the previous findings suggest that *both* questions exhibit this relationship. The source of this discrepancy, detailed below, is in the criteria by which students' responses are sorted. We also describe several limitations to the implications of this analysis, and ultimately motivate subsequent full study.

3.5.1 Discrepancies between Analyses

In the analysis by Crouch and Mazur, students' expressions of confusion were sorted as "related" or "unrelated" to each of the content-related questions. Expressions of confusion about

capillarity and pressure are labeled as “related” to the first question, but expressions of confusion about closely-related topics like contact angles and cohesive forces were not. Moreover, general statements (e.g., everything was confusing) and specific statements (e.g., the question itself was confusing) were also labeled as “unrelated.” Coding according to such criteria necessitates making several assumptions about students’ intent when they make specific statements. In the analysis presented here, we carefully avoid these assumptions using the coding scheme presented in Section 3.3.2. Using these *descriptive* labels of statements made by students – in contrast to *evaluative* (or assumptive) labels – allows us to code each response objectively. Only at the end, after coding is complete, do we determine which descriptive *codes* – not individual responses – should be considered “related” or “unrelated” to each question. Also, as described in Section 3.3.4, multiple researchers worked together to establish the objective validity of the coding criteria presented here. Therefore, the two analyses of the same data differ.

One might argue that this post-coding determination of whether particular expressions of confusion are related to each of the content-related questions could affect the observed relationships. To test this, we also consider different comparisons in our analysis: (1) students who express no confusion and students who express confusion, and (2) students who do not express confusion related to the question under consideration and students who *do* express confusion related to the question under consideration. The results of these alternate sorting criteria agree with the results presented above; therefore, the post-coding determination does not significantly alter the observed relationships.

3.5.2 Limitations of Pilot Analysis

Although the hypothesis introduced above is a viable explanation for these results, it is certainly not the only one. Limitations include: (1) the inability to control for other, potentially significant background variables, (2) the specific way in which questions were posed, and (3) the fact that this reading exercise is only *one* measurement.

A more general metric like the final exam or final grade may better represent student learning or performance, as the reading exercises were not actually evaluated for correctness. The willingness to express confusion may relate more directly to confidence in one's abilities than to performance in the course. These additional variables, among others, could significantly inform – or even alter – the observed relationships.

Even the information we have limits our ability to draw conclusions from the results. As noted above, students were only asked what they found *most* confusing. The group of students who express confusion that is unrelated to the content-related question under consideration may be actually composed of students who are less confused and students who are not confused about the question. If this is the case, the proportion of the students who respond with the correct answer from each of these groups may significantly alter the results.

As this assignment is essentially one data point – there are 151 students, but only one reading exercise – there are numerous alternative hypotheses that account for the observed results. The first question, although challenging, does not necessarily require students to understand capillarity to respond correctly; it is sufficient to recognize that the pressure must be equal at equal heights in a static system. Therefore, expressions of confusion may not correlate with confusion about capillarity for this reason, which has nothing to do with students' metacognition. The second question, for different reasons, does not require students to understand Laplace's

law; the correct response is simply stated in the text. Students may have completed the reading assignment and, appearing to “perform” better than their peers who did not complete the reading assignment, express confusion about the subject. In other words, one question is only superficially related to the material the other question can be answered directly from the reading without any understanding. This may explain why we observe a different pattern of results in the two questions. Moreover, there is no evidence to suggest that students who express no confusion simply did not complete the reading assignment.

We attempt to address all of these shortcomings in the full study, which we describe in the subsequent section. However, some of these challenges stem from the fact that we simply cannot know what students do not say. We can study and interpret expressions of confusion, but we must always acknowledge that students’ expressions of confusion may not precisely correspond to confusions that they have in mind. Only the former, however, is a candidate for assessment of student learning.

3.6 Methods – Full Study

There are several important differences between the pilot analysis and the full study. In the pilot analysis, all of the student responses were entirely free-response. This format is highly conducive to rich student responses, but, barring automated text analysis, we cannot analyze large amounts of such data without a tremendous amount of work. Therefore, in the full study, we modified the format of the questions so that student responses can be analyzed efficiently without sacrificing the detailed information afforded to instructors by the free-response format. This choice allowed us to analyze 43 reading exercises collected over two semesters of instruction.

We designed the questions so that students must critically consider the material (or guess correctly) in order to respond correctly; none of the answers are simply buried in the reading assignment. Moreover, each question requires students to consider content *specific to the reading assignment*, to avoid the situation in which students can reason correctly using other content knowledge.

3.6.1 Course Information

We analyzed data collected from both semesters of a two-semester sequence of introductory physics courses at Harvard University during the fall of 2010 and the spring of 2011. This sequence of courses was designed for non-physics concentrators. A different instructor taught each semester. Both instructors implemented the pre-class components of JiTT and emphasized the importance of completing the reading assignments to the students. The instructor of the first-semester course occasionally posed in-class conceptual questions to students for discussion, but more often presented material through lectures and demonstrations. The instructor of the second-semester course employed PI; demonstrations were used in conjunction with in-class conceptual questions and discussion, and use of lecture was limited. In both semesters, students received credit for participation by responding to both pre-class exercises and in-class questions.

Just as in the pilot study, reading assignments consisted of two content-related questions and a confusion question. The two content-related questions were intended to be thought-provoking and counterintuitive, so students would have to critically engage with the material before class. Questions required students to explain their reasoning. In each assignment, the confusion question was posed *before* the two content-related questions, followed by a final opportunity to

revise the response to the initial confusion question. Students submitted responses online using the ILT.

3.6.2 Measures

In the full study, we analyzed the same two facets of the pre-class reading assignment that we studied in the pilot analysis – student performance on each of the content-related questions and student expressions of confusion – in addition to many other dimensions of student characteristics and course performance. Specifically, we analyzed pre- and post-course performance on the Force Concept Inventory (FCI) or Conceptual Survey of Electricity and Magnetism (CSEM), performance on course-related activities (problem sets, laboratory activities, exams and cumulative grades), and measures of student confidence collected as part of the reading assignments. Additionally, in the spring semester, we analyzed pre- and post-course performance on a survey of self-efficacy in physics.⁴

Conceptual Surveys

In the fall semester, the FCI was administered to assess students' conceptual understanding of Newtonian mechanics (Hestenes et al., 1992). In the spring semester, the CSEM was administered to assess students' conceptual understanding of electrostatics and magnetostatics (Maloney et al., 2001). Both surveys consist of a series of multiple-choice questions that are

⁴ We also administered the Data Handling Diagnostic (DHD) in conjunction with the comparative laboratory study that is discussed in Chapter Four. As we discuss later, the DHD appears to assess a dimension of student engagement that is not probed by the other metrics highlighted here; student expressions of confusion are strongly negatively correlated with pre-test performance on the DHD, even when other variables described here are included in the model. However, inclusion of the DHD does not qualitatively change the relationships between confusion and these other variables, and therefore only complicates the present investigation. Therefore, we note the significance of the DHD but exclude it from the present analysis, in favor of discussing it further in Chapter Four.

designed to elicit students' intuitive ways of thinking – which may or may not be correct – through the use of “everyday” language instead of terminology typical of the physics classroom and response choices that appeal to empirically-identified incorrect ways of reasoning. We present a more thorough discussion of such surveys – and the FCI, in particular – in Chapter Two. The survey is administered as a pre-course assessment during the first week of the semester and as a post-course assessment sometime after the final class meeting and before the final exam. Both surveys are administered through the Internet-based ILT; students have 45 minutes to complete each survey. They received credit for participation, but not for correctness.⁵

Course-Related Performance

If we were to include all of the criteria representing various aspects of students' performance on course-related activities in our analysis, many of the factors would be redundant. Therefore, we employ the statistical technique of factor analysis to determine if the correlations among different variables actually describe one or more uncorrelated aspects of performance (Costello & Osborne, 2005).

For both the fall and spring semesters, we find that reading exercises (evaluated for participation only), laboratory activities, mid-term exams, final exams and final grades all describe virtually *one* factor; the difference between the first and second eigenvalues is much larger than the differences between subsequent eigenvalues. The final exam and final grade are weighted most heavily in determining that factor. Therefore, for simplicity and clarity, we

⁵ Based on our analysis in Chapter Two, perhaps we could treat these conceptual surveys as categorical variables. Indeed, this approach has been done by others (Watkins, 2010). However, in our analysis, we are primarily interested in examining students' pre-course performance, in which there are no ceiling effects. Therefore, we are not inclined to complicate the interpretation of our analysis, while simultaneously suppressing potentially relevant information, if we do not need to do so.

choose to employ final grade as the primary summative measure of students' performance in the course.

Reading Exercises

In order to collect as much information as possible with each reading exercise, we significantly modified the format from that which was used in the pilot study. The confusion question was moved to the beginning of the exercise and consisted of *three* parts. The question was posed as follows:

(1) In the material that you just completed, did you find anything difficult or confusing?

[students select "yes" or "no"]

(2) Which parts were [if "yes" was selected, the word "confusing" appears here; if "no" was selected, the word "interesting" appears here]?

[for each section from the reading assignment, students select "not at all," "somewhat" or "very"]

(3) Please elaborate. Do you have any questions?

Asking the question this way serves multiple purposes. By asking students if they are confused and gauging their confusion on the various topics in the reading assignment, the question is more thorough than simply asking which points students found *most* confusing. Although we cannot claim that all students interpret this question the same way, we no longer have to wonder whether students neglect to express particular confusions because they are merely less confused or, in fact, *not* confused about those topics. Of course, the free-response information is most

valuable to the instructor before each class, so the third part of the confusion question ensures that students can be specific as well as thorough, without too much effort.

We established a quantitative value for confusion based on students' responses to their degree of confusion about topics within a reading assignment. "Not at all," "somewhat," and "very" are associated with the numerical values 0, 1, and 2, respectively, and these values are averaged across all topics listed within a single reading assignment. We call this average value the *confusion index*. If a student expresses no confusion, the confusion index is zero. If a student (1) expresses confusion and (2) is "somewhat" confused about one of two topics and "not at all" confused about the other, that student's confusion index is 0.5. If a student expresses confusion and is very confused on all topics, the confusion index is 2. In this way, we can quantify the degree of confusion of different students.⁶

The content-related questions that follow the confusion question were modified as well. At least two – and sometimes as many as three or four – researchers and instructors reviewed and discussed each question to ensure that they depend upon the content in the reading but cannot be answered by simply locating a key passage in the text. Whenever possible, questions were designed so that the entire space of possible answers could be spanned by the response choices (e.g., *A greater than B*, *B greater than A*, *A and B are equal*). This way, each question could be posed as a multiple-choice question with a free-response field for students to explain their reasoning, and the answer choices do not necessarily influence students' reasoning. Thus,

⁶ One might wonder why we should calculate students' confusion indices when we have already asked them if they are confused. The ability to characterize the *degree* of confusion is certainly valuable, though the yes/no response that precedes it is even easier to interpret. However, degree of confusion is better-suited for statistical analysis; students tend to express *some* confusion relatively frequently, so the yes/no variable is much more skewed toward the upper limit than the confusion index, which is more normally distributed. Therefore, in our analysis, we will characterize student confusion using the *confusion index* variable; any subsequent references to "confusion" should be interpreted as "average degree of confusion."

ideally, we collect readily compiled information and do not direct students to one particular manner of addressing the problem. We approached question development this way because we recognize that instructors often cannot guess what alternate answer choices are going to attract students, but we did not have time to conduct student interviews and establish empirically-based alternate responses for each question.

In posing the content-related questions this way, we also probed one more facet of student understanding: confidence. After explaining their reasoning, students were asked to rate their confidence in the reasoning that they provided on a scale of low, medium and high. These levels were associated with respective numerical values for quantitative analysis.

All of these numbers – confusion indices, correctness, and confidence – convey important information about a single reading assignment. However, if variations from one exercise to the next result in negligible correlations between them, then we have no basis for computing and discussing averages. We conduct factor analysis once again on these variables and find that all of the individual confusion indices, correctness values and confidence ratings are strongly described by *one* factor, respectively. Again, the difference between the first and second eigenvalues is much larger than the differences between subsequent eigenvalues. Therefore, we can safely describe students' averages as representative of the underlying common factor in their individual reading exercise responses.

All of the content-related questions from the reading exercises from both semesters, along with the associated topics of potential confusion, are included in Appendix A.

Self-Efficacy Survey

This survey, administered as a pre-test during the first week of classes on paper and as a post-test between the last class and the final exam via the Internet, was designed to measure both “physics” self-efficacy and “Peer Instruction” self-efficacy. It was based on a similar survey designed to assess physics self-efficacy (Fencl & Scheel, 2004). Seven of the questions related explicitly to students’ belief in their ability to perform physics-related activities, and eight of the questions related explicitly to students’ belief in their ability to engage in Peer Instruction activities. Students responded to questions on a Likert scale (five-point scale from strongly disagree to strongly agree).

The survey was implemented both to assess students’ physics self-efficacy and to investigate whether students’ exhibit Peer Instruction self-efficacy. Only the former is related to our primary research questions – and the latter is the subject of ongoing research – so we only consider the first series of questions, related to physics self-efficacy, in our analysis. This survey was only administered in the spring semester, so we do not consider self-efficacy of students during the fall semester.

To summarize, in this full study, we analyze student expressions of confusion, performance on reading exercises, confidence in their performance on reading exercises, pre- and post-course self-efficacy, pre- and post-course conceptual understandings and performance on graded course activities.

3.6.3 Sample Description

Students completed 22 reading exercises during the fall semester and 21 reading exercises during the spring semester. Data from 139 students were analyzed: 109 from the fall semester and

approximately 90 from the spring semester, of which 60 were enrolled in both semesters. Not all students completed all surveys and not all students completed the course, which explains why we have more reading exercise data than reported final grades.

Table 3.3: Descriptive statistics of characteristics of student learning and engagement, Fall 2010.

variable	N	mean	median	s.d.	range
confusion index	109	0.45	0.43	0.26	0.00 – 1.10
correctness	109	0.77	0.76	0.19	0.32 – 1.37
confidence	109	2.20	2.21	0.32	1.24 – 3.00
FCI, pre	97	17.90	18	6.75	4 – 30
FCI, post	78	22.19	23	6.39	3 – 30
final grade	106	100.57	102.70	17.36	42.11 – 125.99

Table 3.4: Descriptive statistics of characteristics of student learning and engagement, Spring 2011.

variable	N	mean	median	s.d.	range
confusion index	90	0.57	0.60	0.31	0.06 – 1.68
correctness	90	0.85	0.85	0.26	0.30 – 1.62
confidence	90	2.06	2.03	0.39	1.00 – 2.93
CSEM, pre	72	12.76	12	5.73	2 – 27
CSEM, post	55	21.95	23	6.76	6 – 32
final grade	89	85.36	86.44	8.76	57.63 – 99.29
self-efficacy, pre	88	3.51	3.57	0.73	1.14 – 5.00
self-efficacy, post	81	3.45	3.43	0.72	1.00 – 5.00

Table 3.3 and Table 3.4 display descriptive statistics for the measures described in Section 3.6.2. The confusion index, correctness and confidence variables represent the mean for each student across all reading assignments. Accordingly, the average values displayed below are “averages of the averages” of these variables.

3.6.4 Analytic Methods

We investigated the relationships among these factors using multiple regression analysis. Also, as described above, we employed factor analysis techniques to establish which course performance measures should be retained, as well as to justify our use of average confusion indices, confidence ratings and correctness values in our multiple regression models.

For much of the analyses presented here, we calculated the standard score, or z-score, for each of the variables before carrying out multiple regression analysis. The standard score is a representation of the variable after it has been rescaled according to the following equation:

$$z = \frac{x - \mu}{\sigma}, \quad (3.1)$$

where x is the original variable, μ is the mean of the distribution, σ is the standard deviation of the distribution and z is the standard score. We rescale these values for several reasons.

Particularly in the cases of such variables as confusion index, confidence and self-efficacy, the native scales are not readily interpretable, so we can more easily describe observations using standard scores. Analyzing standard scores allows us to compare the relative strength of relationships among variables with different units. However, standard scores can mask whether or not a relationship is meaningful on an absolute scale. Thus, we consider both absolute and standard scores in our analysis. Multiple regression techniques are equivalent, regardless of scale; the calculated coefficients change, but the statistical significance does not.

3.7 Results – Full Study

Whereas the pilot analysis discussed above focused only on the relationship between confusion and correctness, the present analysis involves multiple variables and many different relationships. Thus, we first investigate the pairwise correlations among variables discussed above, for both the fall and spring semesters.⁷

Table 3.5: Pairwise correlations of characteristics of student learning and engagement, Fall 2010.

	confusion index	correctness	confidence	FCI, pre	FCI, post	final grade
confusion index	1.00					
correctness	-0.25**	1.00				
confidence	-0.41***	0.34***	1.00			
FCI, pre	-0.32**	0.58***	0.27**	1.00		
FCI, post	-0.24*	0.57***	0.21	0.71***	1.00	
final grade	-0.04	0.45***	0.24*	0.56***	0.55***	1.00

(* $p < 0.05$, ** $p < 0.01$, *** $p < 0.001$)

As shown in Table 3.5, during the fall semester, confusion appears to be negatively related to each of the other variables. The strengths of these relationships vary; confusion appears to be strongly negatively related to confidence and not at all related to final grade. However, we also

⁷ We consider pairwise correlations because, as shown in Table 3.3 and Table 3.4, participation rates vary across different measures of student learning and engagement. Instead of diminishing our statistical power by limiting analysis to only those students who completed *everything*, we compare students who completed everything to those who did not complete everything to confirm that the fluctuations in participation do not bias our analysis. Comparisons of the means indicate that the two groups are not significantly different from one another. Therefore, we are confident that our analysis is not biased from fluctuations in participation.

see that the variables are strongly related to one another, suggesting that multiple regression analysis of confusion and these other variables may reveal very different relationships.

We see that relationships during the spring semester, shown in Table 3.6, are very similar to those observed in the fall semester. Self-efficacy is strongly negatively related to expressions of confusion, though it is also strongly related to virtually all of the other characteristics under consideration here.

Table 3.6: Pairwise correlations of characteristics of student learning and engagement, Spring 2011.

	confusion index	correctness	confidence	CSEM, pre	CSEM, post	final grade	self-efficacy, pre	self-efficacy, post
confusion index	1.00							
correctness	-0.34**	1.00						
confidence	-0.52***	0.39***	1.00					
CSEM, pre	-0.25*	0.51***	0.36**	1.00				
CSEM, post	-0.22	0.43**	0.30*	0.58***	1.00			
final grade	-0.12	0.57***	0.26*	0.48***	0.71***	1.00		
self-efficacy, pre	-0.50***	0.34**	0.50***	0.29*	0.25	0.37***	1.00	
self-efficacy, post	-0.41***	0.47***	0.55***	0.34**	0.38**	0.55***	0.81***	1.00

(* $p < 0.05$, ** $p < 0.01$, *** $p < 0.001$)

Regression Analysis

To explore the interactions among these characteristics simultaneously, we build a series of multiple regression models. As the primary goal of this analysis is to better understand what student expressions of confusion tell us, we treat confusion (“confusion index”) as the outcome variable in the models presented below. Although final grade may seem like a more natural outcome variable because it is also an outcome of the course, merely including confusion as a covariate does not adequately convey how it relates to other variables in the model.

Although we can build regression models in which both pre-test and post-test surveys are included, the strong relationship between the two rounds of surveys renders one or both of them statistically insignificant; we find this to be true of the FCI in the fall and of the CSEM and self-efficacy survey in the spring. Thus, we consider only pre-tests of each survey in our regression models.⁸

Table 3.7 and Table 3.8 summarize the most revealing regression models from the fall and spring semesters, respectively. Standard coefficients are displayed. When only expression of confusion and reading exercise correctness are included in the model (models 1f and 1s), there is a statistically significant negative relationship between the two variables; in other words, when no other variables are included in the model, an increase in correctness of one standard deviation is associated with a decrease in confusion of approximately 0.25 standard deviations during the fall semester and 0.34 standard deviations in the spring semester. However, only 6.2% and 11.7% of the variation in confusion is explained by correctness in the fall and spring semesters, respectively.

⁸ The pre-test is more useful than the post-test as a covariate because it allows us to interpret the multiple regression analysis as a predictive model.

Table 3.7: Fitted linear regression models predicting expression of confusion by selected variables of student learning and engagement, Fall 2010.

variable	model 1f	model 2f	model 3f	model 4f
N	109	109	106	95
correctness	-0.25**	-0.12	-0.16	-0.05
confidence		-0.37***	-0.41***	-0.37***
final grade			0.13	0.16
FCI, pre				-0.29*
R ²	0.062	0.185	0.208	0.247
RMSE	0.97	0.91	0.91	0.90

(* $p < 0.05$, ** $p < 0.01$, *** $p < 0.001$)

Table 3.8: Fitted linear regression models predicting expression of confusion by selected variables of student learning and engagement, Spring 2011.

variable	model 1s	model 2s	model 3s	model 4s	model 5s
N	90	90	89	88	72
correctness	-0.34**	-0.17	-0.28*	-0.26*	-0.26*
confidence		-0.45***	-0.45***	-0.31**	-0.34**
final grade			0.16	0.23*	0.37**
self-efficacy, pre				-0.34**	-0.41***
CSEM, pre					-0.03
R ²	0.117	0.289	0.317	0.401	0.496
RMSE	0.94	0.85	0.84	0.80	0.76

(* $p < 0.05$, ** $p < 0.01$, *** $p < 0.001$)

When confidence in one's explanation of the reading assignment is introduced into the model (models 2f and 2s), the relationship between confusion and correctness is no longer statistically

significant. In other words, the negative relationship between confusion and correctness in models 1f and 1s appears, in fact, to result from confusion and correctness both being strongly related to confidence and only being weakly related to one another when confidence is held constant. There is a strongly statistically significant negative relationship between confusion and correctness during both semesters.

When final grade is introduced into the model (models 3f and 3s), it is not statistically significant in either semester. However, interestingly, the relationship between confusion and final grade is *positive* in this model. In the fall semester, neither correctness nor final grade is statistically significantly related to confusion; only confidence is statistically significantly related, and the relationship is strongly negative. In the spring semester, even though final grade is not statistically significantly related to confusion, the introduction of final grade into the model strengthens the negative relationship between correctness and confusion. So, in this case, correctness *and* confidence are negatively related to expressions of confusion.

The next few models differ between the fall and spring semesters. In the fall (model 4f), FCI pre-test performance is significantly negatively related to confusion, although its inclusion does not qualitatively change the relationships among confusion, reading exercise correctness and final grade. In the spring (model 4s), student pre-semester self-efficacy is introduced. When self-efficacy is considered alongside final grade, confidence and reading exercise correctness, all four of the variables are statistically significantly related to confusion. Perhaps most interestingly, final grade remains positively related with expressions of confusion; an increase in score of one standard deviation on the final exam is associated with an increase of 0.23 standard deviations of confusion. Model 5s is included only to show that these relationships persist even when

controlling for CSEM pre-test performance; one might believe that controlling for students' background knowledge could alter these relationships, but model 5s indicates that this is not so.

To better illustrate these relationships, in Figure 3.3 we highlight models 3f, 3s and 4s described above. These three models are shown in different colors. Because each variable is represented as a standard score, all of the variables may be represented on the same scale.

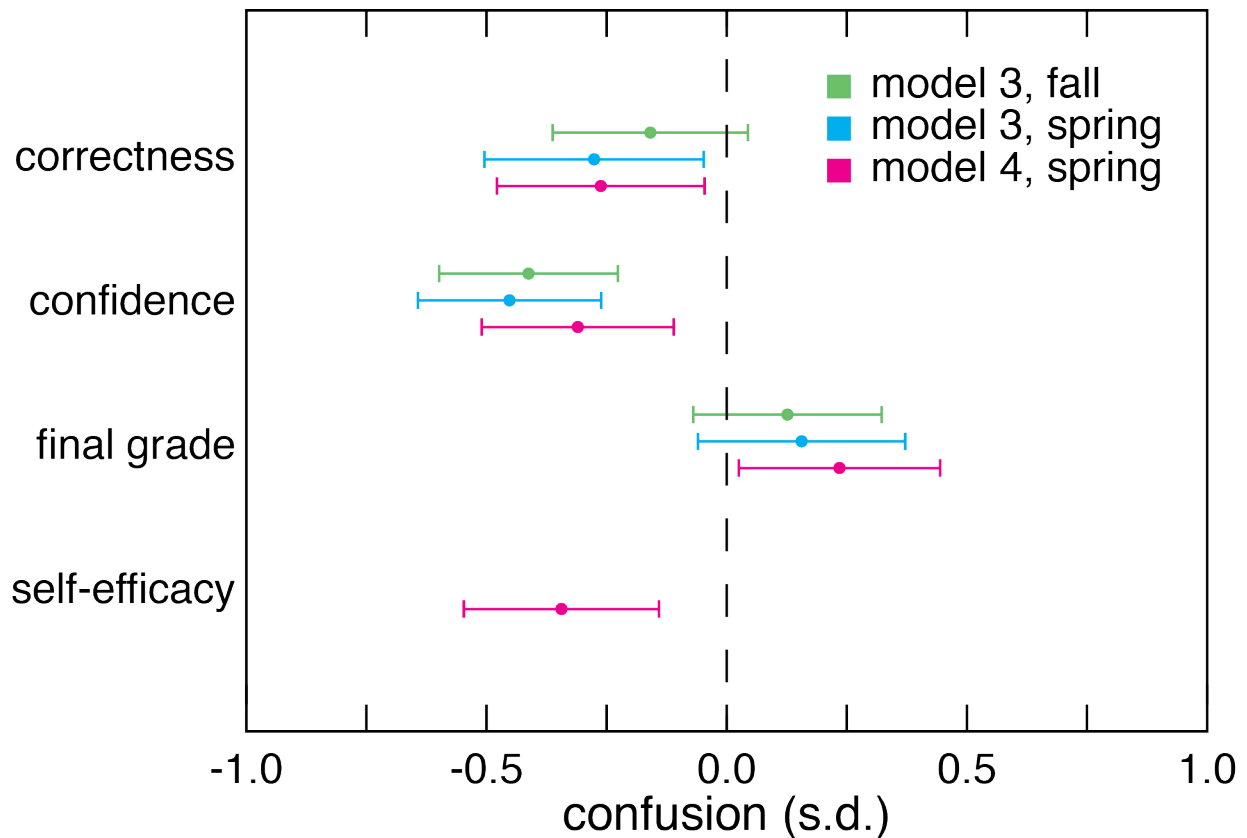

Figure 3.3: Fitted linear regression models predicting expression of confusion by selected variables of student learning and engagement. Models 3f, 3s and 4s are displayed here. Each color represents a different model. The bars represent the 95% confidence interval around each of the mean values; if the confidence interval does not include the “zero line,” then the difference is statistically significant at the 0.05-level.

We see that the relationship between confusion and final grade is positive in all of these models, while the relationships between confusion and each of the other variables are negative. The same

relationships hold true in models 4f and 5s, which are shown in Table 3.8 and Table 3.9, respectively; they are omitted from Figure 3.3 for simplicity.

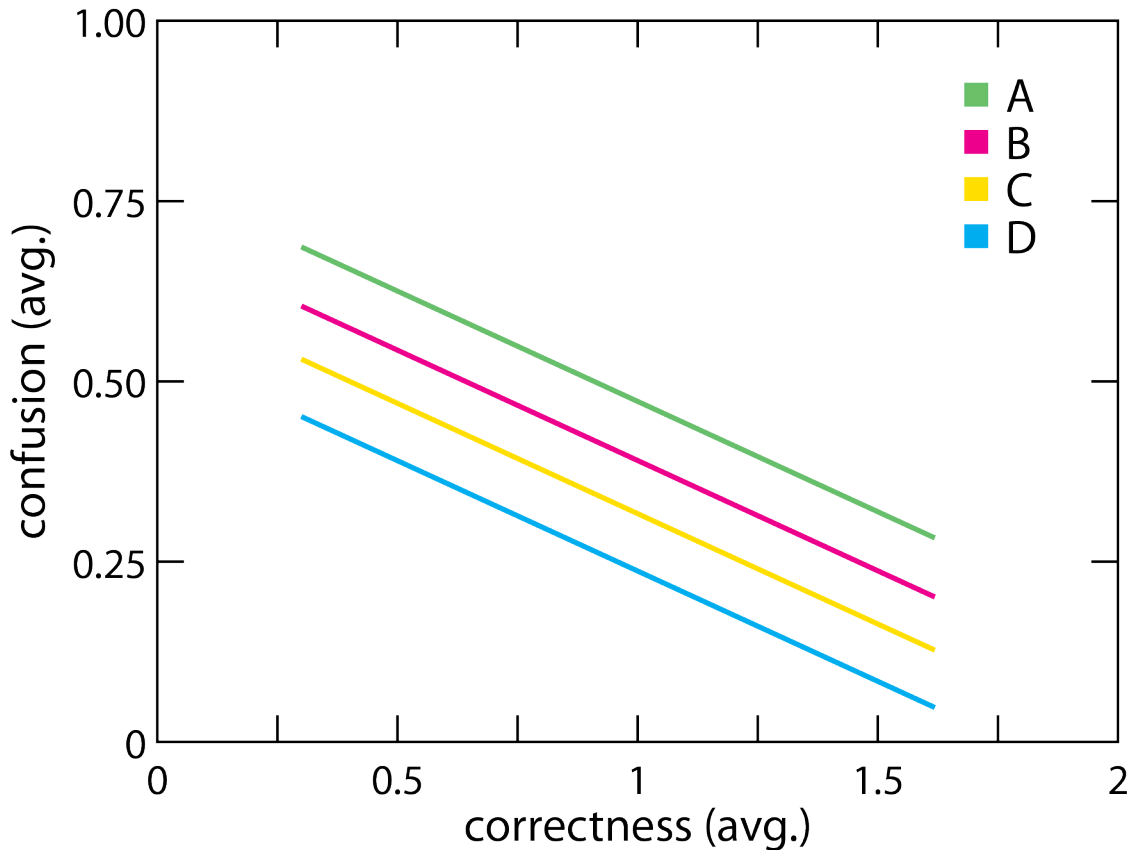

Figure 3.4: Expression of confusion regressed against reading assignment correctness. Model 4s is displayed in this prototypical plot of average confusion index against reading assignment correctness at final grades of A, B, C and D, using native units (rather than standard scores). These lines represent the fit to actual data; the data are not displayed here.

To further highlight the relationships between confusion and the two performance measures – final grade and reading exercise correctness – from model 4s, we display a series of linear regression lines relating confusion and correctness that are associated with a range of associated final grades in Figure 3.4. In this case, we are no longer using standard scores; the plot area ranges from “not at all” confused (0) to “somewhat” confused (1) on the vertical axis and from “0 out of 2” to “2 out of 2” on the horizontal axis. Students of approximately the same level of

initial performance, confidence and self-efficacy who express more confusion tend to also perform better than students who express less confusion. We do not observe any interaction effects among the variables considered in this model.

Altogether, these variables explain 40.1% of the variation in confusion during the spring semester; when CSEM performance is included, as shown in model 5s, the model actually explains 49.6%. In the fall, however, the variables explain only 24.7% of the variation in confusion. The rest of the variation may be noise, or representative of other dimensions of student affect and performance that are not captured by the covariates presented here.

3.8 Discussion – Full Study

In averaging student expressions of confusion, confidence and correctness on reading exercises over the semester, we effectively neutralize the effects of the spurious alternative hypotheses that hindered the pilot analysis. Fortunately, we did not neutralize the main effects that we were interested in studying.

The negative relationship between expressions of confusion and correctness on reading exercises (models 1f and 1s) is contrary to the relationship suggested by our pilot analysis. However, this finding is not necessarily surprising when we consider the large amount of variation in expressions of confusion that is not explained by reading exercise performance; the variables are related, but not very strongly. We note that, of the 43 reading exercises from both semesters, 10 of them exhibit positive correlations between students' expressions of confusion and reading exercise performance. Therefore, it is possible that there are no fundamental differences between the pilot analysis and the full study, and statistical fluctuations account for the seeming discrepancy. On the other hand, as discussed in Section 3.5.2, there are several

alternative explanations for the observed pattern in the pilot analysis that cast doubt on whether it reflects the relationship of interest. Either way, we have no reason to doubt the validity of the relationship observed in the full study.

When final grade, confidence and self-efficacy are considered alongside reading assignment correctness, we find that confusion is associated with both positive and negative course outcomes. The suggestion of Crouch and Mazur (C. Crouch, 2000) that students who express confusion about the content also tend to outperform others on the reading exercises is not supported by these observations. However, the more nuanced notion that students who express more confusion also tend to perform better *in the end*, assuming we control for other relevant factors, *is* supported by these observations. Thus, we cannot claim that confusion is exclusively good or bad; rather, we make two claims:

- (1) When relevant factors are *not* controlled for, expressions of confusion are either negatively-related or unrelated to reading exercise performance, confidence, final grade and self-efficacy. Thus, expressions of confusion may be “bad,” or merely uninformative.
- (2) When relevant factors *are* controlled for, expressions of confusion are negatively-related to reading exercise performance, confidence and self-efficacy but positively-related to final grades. Thus, assuming that we are interested in predicting final grades and therefore controlling for other variables, confusion is “good.”

In other words, we are able to identify “productive confusion,” or the productive role of confusion, but it is mixed with other, unproductive types of confusion in such a way that one cannot isolate it without collecting additional information from students. We will discuss the implications of these findings for instructors below.

In our discussion of self-efficacy, self-concept, metacognition and the role of confidence as a means of probing these various theoretical elements of student engagement, we struggled to establish which constructs are interchangeable and which constructs are distinct. In addition to exploring the relationship between confusion and correctness, our present empirical efforts may shed some light on the *practical* distinctions between these *theoretical* ideas.

3.8.1 Metacognition, Confidence and Self-Efficacy

The multiple regression analyses presented above suggest that the three probes of self-regulated learning employed here – expressions of confusion, ratings of confidence, and evaluation of physics self-efficacy – are distinct means of probing student engagement. Perhaps this is surprising, as researchers have used confidence as a proxy for self-efficacy in previous studies (Andrew, 1998). We find that students' physics self-efficacy, expressions of confusion, and confidence in their explanations are among the most highly-correlated factors considered in this study, but the correlations, displayed in Tables 3.6 and 3.7, range from 0.4-0.6; none of the factors are close to being co-linear. Thus, either the underlying constructs assessed by each of these factors are different, or the various means of assessment – the different questions, contexts, etc. – lead students to reply in different ways.

Ultimately, a theoretical framework that suppresses the subtleties that arise from the interplay of these factors is not sufficient for describing this system. As our results show, the models only explain a fraction of the variation in student expressions of confusion, and many of the relationships change – or even reverse – when additional parameters are introduced. However, while we claim that a robust theoretical framework should not collapse confidence, self-efficacy and confusion together as a representation of metacognition, we cannot associate the variables

measured in this study with clear theoretical counterparts. One might argue that our probe of self-efficacy is more akin to a probe of students' "self-concept" (Linnenbrink & Pintrich, 2003; Pietsch et al., 2003) because it is an assessment of students' general beliefs in their abilities rather than their beliefs in their ability to carry out specific skills, but such arguments require the development of much more extensive, theory-focused research inquiries.

3.8.2 Changing the System by Measuring

We acknowledge that the act of asking students to participate in so many "metacognitive activities" throughout the year could certainly change their behavior. We do not know, for example, the extent to which confidence and performance are positively related simply *because* students were asked about their confidence.

JiTT and PI are designed to make physics instruction more metacognitive. Frequent opportunities for reflection about sources of confusion, coupled with collaborative interactions in the classroom and a strong focus on the value of self-directed learning, are built on the assumption that learning outcomes benefit from such activities. We note that, despite the much more prominent role of lecture during the fall semester, the relationships observed across both semesters are qualitatively similar.

In spite of all the metacognitive exercises, the average self-efficacy score of students in the course virtually did not change over the duration of the spring semester (Table 3.5). This is somewhat surprising, as we might have expected to observe some positive changes.

3.8.3 Implications for Instruction

There are two distinct questions about confusion that are particularly relevant to instruction: (1) should we assess students' expressions of confusion, and (2) how do we interpret students' expressions of confusion? The answers to these questions depend on the manner in which confusion is assessed.

When relevant factors are *not* controlled for, expressions of confusion are either negatively-related or unrelated to reading exercise performance, confidence, final grade and self-efficacy. Thus, if instructors assess expressions of confusion in such a way that they are unable to control for the factors considered in this study, then “the less confusion, the better.” However, given that the relationship between course outcomes and expressions of confusion is so weak, the best advice may be simply to avoid assessing expressions of confusion *in such an uncontrolled way*.

On the other hand, when relevant factors *are* controlled for, expressions of confusion are negatively-related to reading exercise performance, confidence and self-efficacy but positively-related to final grades. Thus, if instructors assess confusion in such a way that they can control for these negatively-related factors, such as the means of assessing confusion that is presented here, then they can distill the productive role of confusion from the unproductive roles.

Monitoring the productive role of confusion affords instructors the opportunity to both assess students' metacognition as they engage in activities and perhaps even promote such constructive expressions of confusion.

Ultimately, expressions of confusion, when carefully assessed, can play a positive, important role in instruction.

3.8.4 Limitations

We note several specific limitations of this study.

Asking students to express their confusion before responding to content-related questions could introduce a stereotype threat that affects performance. This effect would induce a negative relationship between confusion and correctness, which is precisely what we observed; we cannot determine the extent to which this stereotype threat may be amplifying the negative relationship. Ironically, the confusion question was posed before the other questions because we did not want to introduce bias in the other direction; that is, we did not want to influence students' responses about their confusion by asking them challenging questions about the reading assignment immediately beforehand. We were also concerned that students would say, "I am confused about the previous question," rather than something related to the reading (in the fourth "follow-up" question, many students responded in precisely that way).

Another limitation of our analysis is that we depend upon students to rate their confidence, confusion and physics self-efficacy on scales that are not calibrated to any external standards. One student may interpret his/her abilities and understandings very differently than another student who, objectively, may be very similar. In addition to the potential disconnect between what students think and what they express, this lack of calibration introduces another potential disconnect between what students express and what they *mean* to express. Ideally, we would develop calibration activities that students could use to gauge their own responses, but we are also very conscious of the low tolerance students have for inconveniences. When more work is required to complete the assignment, the likelihood that students will skip the introspection process increases. Perhaps descriptive rubrics or sample responses would help, though such materials may bias responses of students.

3.8.5 Future Directions

The relationship between expressions of confusion and student *reasoning*, not merely correctness, could be much more revealing. As we have this data already, one potential direction of future research involves analyzing students' explanations to investigate how these relate to expressions of confusion. Furthermore, the free-response data collected here can be used to inform and redesign the multiple-choice component of the questions posed over the course of this study. From this data set, we can also identify particular students – high-performing students who express slight confusion, low-performing students who express much confusion, etc. – and investigate their free-response data to better understand confusion as a form of assessment.

From a more theoretical point of view, now that we observe students' distinct responses to separate measures of confidence, confusion, and self-efficacy, we are able to explore the ways in which each of these measures relates to the theoretical constructs of self-concept, self-efficacy, metacognition, motivation, identity, and numerous other components of the theories described in Section 3.2. Perhaps we must consider the possibility that self-efficacy, like knowledge (diSessa, 2006), exists in pieces and may or may not be activated in different contexts.

Finally, from a more practical point of view, now that we observe a productive role of confusion in instruction, we may be able to further explore the causal relationships between this kind of confusion and course outcomes. Additionally, we may be able to explore the relationship between changes in expressions of confusion, as well as changes in the *productiveness* of confusion, to specific activities in class.

3.9 Conclusion

Students who express more confusion tend to also express lower confidence, lower self-efficacy, and, to a slight degree, weaker performance on reading exercises. However, when we control for all of these factors, students who express confusion tend to also perform better overall, as measured by final grade. Thus, we suggest that, when relevant factors are *not* controlled for, expressions of confusion may be either bad or merely uninformative; but when relevant factors *are* controlled for, assuming that we are interested in relating assessment of confusion to final grades, confusion is good. In other words, we are able to identify and isolate the productive role of confusion using surveys and reading assignment activities that are entirely accessible to instructors. Thus, if instructors assess confusion as presented here, then they can monitor the productive role of confusion, assess students' metacognition as they engage in activities, and perhaps even find ways to promote such constructive expressions of confusion.

Chapter Four

Exploring “Design” in the Introductory

Physics Laboratory

The introductory physics laboratory, sometimes treated as an appendage to the primary physics course, actually plays a very important role in physics education. Many of the activities that students undertake and the skills that they learn are (1) essential to a well-rounded understanding of the theory and practice of physics and (2) primarily accessible and assessable in the laboratory setting (Singer et al., 2006). Therefore, we explore this dimension of student learning and engagement by investigating students’ exhibition of scientific reasoning and data handling skills in laboratory activities designed with different

degrees and means of scaffolding inquiry. Our goal is to compare *each* of these approaches to inquiry, which are described in detail below, to one another and to compare *both* approaches to other institutions where comparably structured inquiry-based laboratory activities are implemented. We observe slight differences between the groups, and we find that even some of the most strongly-emphasized skills are either not exhibited or not retained by many of the students.

4.1 Introduction

Traditional laboratory exercises often involve carrying out a specified procedure, measuring some physical parameters, and performing quantitative analysis. The intent is usually to provide “hands-on” experience in science to students, reinforce the rules and relationships presented in lecture, and convey a sense that science is *cool*. Other potential goals, such as clarifying the scientific method and improving student understanding of measurement, error, and assumptions, are often not articulated and largely neglected during instruction.

Therefore, we assess how different strategies in laboratory instruction impact the achievement of various learning and skill development goals.

4.2 Background

As this study is focused on the redesign and implementation of two pedagogical approaches, we begin by motivating such changes from a goal-oriented perspective. We discuss previous research in the design of instructional laboratories. To better contextualize our results, we consider several theories related to *transfer* of knowledge. Transfer is important because, once we establish that laboratory activities should focus on scientific reasoning skills, the variations in

content from one lab to the next are actually just changes in context. Thus, we must have a productive model of transfer to understand our observations.

4.2.1 Learning Goals in the Laboratory

Reif and St. John find that students are unable to articulate the central goal of an experiment, its underlying theory, or its basic methods in “traditional” laboratory classes where laboratory activities are not built around goals and goals are not clearly articulated to students (F. Reif & John, 1979). Subsequent studies have reinforced this finding (Domelen & Heuvelen, 2002; Richard R. Hake, 1992; Patricia Heller & Hollabaugh, 1992; Patricia Heller, Keith, & Anderson, 1992; Hofstein & Lunetta, 1982; Redish, Saul, & Steinberg, 1997; Redish et al., 1998; F. Reif & Reif, 1987; Wells et al., 2008). All of these studies involved the identification of learning goals. Welzel and colleagues collected survey responses from hundreds of laboratory instructors and summarized results in the following goal categories (Welzel et al., 1998):

- (1) for the student to link theory and practice;
- (2) for the student to learn experimental skills;
- (3) for the student to get to know the methods of scientific thinking;
- (4) for the student to foster motivation, personal development and social competency; and
- (5) for the teacher to evaluate the knowledge of the student.

These general categories provide a framework for discussing the different goals emphasized by science education researchers in other settings. “Traditional” laboratories focus largely on the first and second goal categories, even though specific goals are not always made explicit.

Scientific Community Laboratories

Scientific Community Laboratories (SCLs), developed at the University of Maryland, are designed to teach students how to produce, analyze and evaluate scientific evidence (Kung, 2005; Lippmann, 2003). This goal is encapsulated by the second and third categories listed here. The printed materials that are distributed to students include a very brief description – perhaps one short paragraph – of the phenomenon under consideration, one primary question, and a timetable describing how much time students should devote to each stage of the process.⁹ Students are expected to investigate the primary question using materials that are available. Class-wide discussions take place between stages of planning, data collection, analysis and reporting. In reporting on the effectiveness of these laboratories, Lippmann Kung reports that students struggle with the idea of measurement, particularly when it's related to uncertainty (Kung, 2005).

ISLE Design Laboratories

Etkina and colleagues have developed and implemented the investigative science learning environment (ISLE) instructional design laboratories (Etkina et al., 2010). The printed materials that are distributed to students include a statement of learning goals, a series of experimental inquiries, and descriptions of the scientific abilities upon which these activities focus.¹⁰ Each inquiry – experiment, investigation, question, etc. – is followed by a series of steps that guide students through the inquiry process. Etkina and colleagues define very specific criteria for evaluating student understanding of uncertainty and scientific assumptions (among other

⁹ More information and complete SCLs are available here:
<http://umdperg.pbworks.com/w/page/10511229/Scientific%20Community%20Labs>

¹⁰ More information and complete ISLE design laboratories are available here:
<http://paer.rutgers.edu/ScientificAbilities/Design+Experiments/default.aspx>

scientific abilities). They find that students do not “saturate” these scientific abilities after one semester of instruction (Etkina et al., 2008). Additionally, they report that design laboratories are not as effective without strong scaffolding – reflection, historical reading passages, and rubrics – and non-design laboratories are even less effective. These findings support the notion that scientific abilities are not trivially linked to the laboratory setting.

Summary

While all of these novel designs, as well as the associated evaluation measures, appear to be very effective at improving scientific abilities in the laboratory, there are still unanswered questions. Both SCLs and design laboratories focus on developing scientific skills and abilities, but are not optimized to maximize physics content. This is not to say that these laboratories do not *include* physics content; rather, instead of spending more time on addressing sophisticated material, they allow for more emphasis on design and inquiry.

Depending on the goals of the laboratories in an introductory science course, the optimal strategy for laboratory design and implementation may vary. We assert that the primary goal of the laboratory is to enhance scientific reasoning skills, primarily because this is an important goal and the student laboratory is the only component of the introductory physics course where such a goal is possible. In this case, the optimal strategy may involve less emphasis on advanced content and more emphasis on scientific abilities.

4.2.2 Degree of Guidance

Hand-in-hand with the discussion of laboratory goals is the discussion of the degree of guidance that an instructor provides to students. If content-oriented goals require students to have a

sophisticated understanding of the material, time constraints may necessitate stronger guidance in the content and design of the laboratory. However, strong guidance may not be associated with the most effective learning.

Through an investigation of student engagement using Physics Education Technology (PhET) simulations, Wieman and Adams observed that limited guidance is superior to stronger guidance for student engagement, as measured by monitoring the extent to which students explored PhET simulations and the number of questions students asked the moderator as they worked (Wendy K Adams, Paulson, & Wieman, 2008). They identify four degrees of guidance: “no instruction,” in which students are asked to play with the simulation and talk out loud as they try things; “driving questions,” in which simulation work is preceded by some relevant general conceptual questions; “gently guided,” in which the simulation work is accompanied by specific questions that are related to the activity; and “strongly guided,” in which the activity is dictated in step-by-step format. They suggest that the “no instruction” and “driving questions” strategies allow students to form and investigate their own questions, and thus more effectively build from their own understanding of the material. Wieman and Adams point out that “no instruction” fails, however, if the simulation is too complex or poorly designed.

Even without additional questions, the simulations themselves implicitly provide guidance. Although the study described here relates to physics simulation activities, the interactive, self-directed approach to learning is analogous to the laboratory environment. The laboratory setting is inherently more complex, and the environment contains inherently less guidance, suggesting that students are more likely to fail to engage without some degree of scaffolding.

Scaffolding

Holton and Clark describe scaffolding, a general term that includes the elements we consider “degrees of guidance,” in relation to metacognition and social activities involved in learning (Holton & Clarke, 2006). They identify three types of scaffolding – expert scaffolding, reciprocal scaffolding and self-scaffolding, which is equivalent to metacognition – and two scaffolding domains: conceptual and heuristic.

Conceptual scaffolding targets conceptual development, whereas heuristic scaffolding attempts to transcend specific content to promote heuristics for learning and problem solving. In describing metacognition, Schraw and colleagues describe heuristic scaffolding in different terms, instead referring to declarative, procedural and conditional knowledge of cognition (Schraw et al., 2006).

SCLs, introduced above, contain very limited scaffolding on paper; ISLE design laboratory exercises, in contrast, contain extensive heuristic scaffolding and very limited conceptual scaffolding. However, both approaches to the laboratory contain many opportunities for discussion among peers and with instructors, which is intended to play a heuristic (rather than conceptual) role.

4.2.3 Transfer

The importance of the ability to transfer skills and knowledge from one domain to another plays a role in virtually all of the theoretical frameworks discussed in previous chapters. In discussing self-efficacy, Bandura comments that experiences of success are more likely to affect personal efficacy when threats are mastered in various circumstances (Bandura, 1977). Georghiades suggests that metacognition may mediate improvement of transfer and durability of scientific

conceptions in the framework of conceptual change (Georghiades, 2000). The process of conceptual change is not complete unless there is evidence that the newly-changed concepts can be transferred to different contexts; the decay of conceptual change over time from an inability to transfer skills and concepts is, therefore, a central problem in education. Georghiades argues that transfer is not synonymous with “application” because application is only part of the process of transfer; before applying, one must recognize that the knowledge can transfer, determine which elements change and which elements do not change and then test applicability. In linking transfer to teaching practices, Georghiades highlights metacognition, and specifically metacognitive activities together with social activities, as a way of overcoming the decay in conceptual change (Georghiades, 2000).

Challenges to Classical Transfer Theory

Broadly speaking, classical transfer theory refers to the association of common elements from one context to another; the notion of what constitutes an “element” has evolved with the development of theories of cognition, but the underlying principle remains. Georghiades’ characterization of transfer is slightly different than the classical transfer theory. He treats transfer and learning as largely synonymous, in that a failure to transfer is essentially a failure of conceptual change. However, this fusion of transfer and learning actually side-steps fundamental flaws in the classical treatment of transfer (Lobato, 2006). Challenges to the classical theory stem from the potentially unique ways in which individuals detect similarities across situations and the importance of distinguishing between superficial and deep, structural elements. Lobato, citing others, highlights five theoretical problems with the classical transfer approach (Lobato, 2006):¹¹

¹¹ Items are enumerated here for clarity; the quoted passage appears in paragraph form in the original publication.

- (1) Classical transfer studies privilege the perspective of the observer and rely on models of expert performance, accepting as evidence of transfer only specific correspondences defined a priori as being the “right” mappings (Lobato, 2003; Seeger & Waschescio, 1998). [...]
- (2) At the root of the transfer problem is a functionalist view of knowledge in which “the beneficial cognitive consequences of decontextualized learning, freeing oneself from experience” are seen as “a condition for generalization about experience” (Lave, 1988, p. 41). [...]
- (3) According to critics, transfer researchers often interpret context as task presented to students and analyze the structure of tasks independently of students’ purposes and construction of meaning in situations (Carraher & Schliemann, 2002; Cobb & Bowers, 1999; Greeno, 1997).
- (4) The “applying the knowledge” metaphor of transfer suggests that knowledge is theoretically separable from the situations in which it is developed or used, rather than a function of activity, social interactions, culture, history and context. [...]
- (5) The static nature of the application or transportation metaphor suggests that “the formation of transfer environments is not assumed to be an actual part of the process, but rather is seen as differentially supporting or interfering with it” (Tuomi-Gröhn & Engeström, 2003, p. 40). (p. 434)

Some researchers address the challenges and shortcomings by distinguishing between different kinds of transfer. Perkins and Salomon consider transfer as they shift from discussing “expertise” as a general quality towards context- and content-specific expertise (Perkins & Salomon, 1989). They suggest that people fail at “transfer tasks” because they are too *good* at transfer and apply too much from the familiar situations to new situations. They modify classical transfer theory by introducing two kinds of transfer: the “low road” to transfer, which depends on extensive and varied practice, and the “high road” to transfer, which depends on deliberate abstraction of a principle. McKeachie suggests that, in some situations, low-road, automatic processes are more productive than high-road, metacognitive processes when the latter interfere with the former (McKeachie, 1987).

However, such distinctions do not address the problems with classical theory because transfer is still treated as an unproblematic construct where the only challenge is facilitating its occurrence (Lobato, 2006). Classical transfer theory suffers from the fact that there is little agreement about what transfer actually means (Barnett & Ceci, 2002).

Alternatives to Classical Transfer Theory

Some believe that transfer is fundamentally flawed as a research construct because we must either (1) reject the notion of transfer, and therefore also reject constructivism, or (2) accept the notion of transfer, and also accept some vague ideas about how knowledge, abstraction and context are conceived (Carragher & Schliemann, 2002). Abstraction seems at odds with theories of contextualized learning unless researchers adopt a different view of abstraction (Lobato, 2006). Several alternative conceptions of abstraction stem from *reflective abstraction* (Jean Piaget, 1980), described as “a constructive process in which the regularities abstracted by the learner are not inherent to the situation, but rather are a result of personal structuring related to the learner’s goals and prior knowledge” (Lobato, 2006, p. 441).

Lobato’s alternative to classical transfer theory is *actor-oriented* transfer. From the actor-oriented perspective, the focus shifts from the instructor’s viewpoint to the student’s viewpoint (Lobato, 2003). The goal is to understand how learners generate – or fail to generate – their own similarities between problems. This shift in focus modifies the criteria for evidence of transfer; whereas classical transfer theory considers strong performance in a different task to be evidence of transfer, the actor-oriented perspective considers the act of drawing similarities between new situations and previous experiences evidence of transfer.

Lobato also discusses mechanisms of transfer (Lobato, 2006). Such mechanisms include “focusing phenomena,” features in a classroom environment that direct students’ attention toward certain properties or patterns, and “social framing,” a way of framing both activities and students’ roles as being connected with other contexts in which the learning experiences are relevant, and “discernment of differences,” in which students consider differences between situations to ultimately refine transfer ability.

4.3 Methods

Transfer effectively characterizes the learning that takes place in the introductory physics laboratory because each activity is a different means of encountering and building on the same underlying set of skills. Students may encounter new concepts and engage with content that is still somewhat unfamiliar, but the scientific reasoning skills are reinforced in *every* session in different contexts. Regardless of how well defined the theoretical framework for describing such transfer of skills is, students must be able to translate experiences from one context to another in order to be successful in the laboratory. Moreover, instructors must be able to assess this transfer.

This study investigates student exhibition of scientific abilities in the instructional laboratory setting. We approach this analysis through the lens of the instructor, who cannot scrutinize video-recorded discussions and activities for evidence of sense-making and critical thinking. Although such methods are invaluable research tools and could provide insight into this subject, logistical constraints prevented us from conducting such discourse analysis in this investigation.

4.3.1 Course Information

We analyzed data collected in the second semester of a two-semester sequence of introductory physics courses at Harvard University during the spring of 2011. This course focused on topics related to electricity and magnetism and was designed for non-physics concentrators. As described in Chapter Three, the instructor employed Peer Instruction (PI); demonstrations were used in conjunction with in-class conceptual questions and discussion, and lecture was limited.

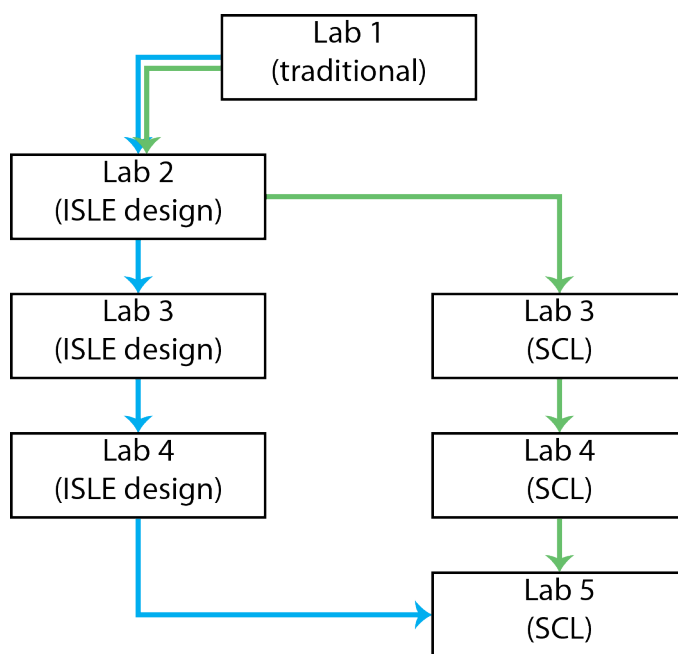

Figure 4.1: Dual sequences of introductory laboratory activities. The two sequences, involving ISLE design labs (heuristically scaffolded, inquiry-based activities) and SCLs (exploratory, virtually no formal scaffolding) after an initial traditional lab (heavily scaffolded, both heuristically and conceptually) are displayed here. Blue and green arrows, respectively, represent the two sequences.

The laboratory component of the course involved five bi-weekly – i.e., meeting on alternating weeks – sessions over the duration of the semester. Laboratory activities were related to content that was being discussed concurrently in the classroom and recitation sections. Each

student enrolled in one of six laboratory sections, and each section took place at a different time. The sequences of laboratory activities were designed as follows: the first session was relatively traditional, with explicit procedures and step-by-step instructions; the second session was closely modeled after the design labs developed for ISLE, with extensive heuristic scaffolding but very limited conceptual scaffolding; the third and fourth sessions were split so that activities closely modeled after the ISLE design labs were carried out in three sections and activities closely modeled after SCLs, which were largely exploratory with virtually no formal scaffolding, were carried out in the other three sections; and the fifth session was modeled after SCLs. These sequences are illustrated in Figure 4.1.

After enrollment, we determined which laboratory sections would receive which sequence of activities based on two criteria: (1) the number of students participating in each sequence should be approximately equal to one another and (2) more scaffolded activities should take place *after* less scaffolded activities whenever possible. Students were permitted to attend a different section if they had a conflict with their regular section before the third meeting (i.e., before the split); however, students were required to continue attending the same section once different sequences were established.

No pre-laboratory exercises were assigned, and reports were always submitted at the end of the three-hour session. These reports included a statement of purpose, hypothesis and predictions, experimental procedure, collected data, analysis of collected data and conclusions. Students worked in groups of two, three or four students and submitted laboratory reports as a group. Students were not required to form the same group each week. They were encouraged to work diligently throughout the session but not to worry if they did not finish the exercises, since they would be evaluated on the quality of the report rather than the number of activities they

completed. Rubrics developed for use with Design Labs were used to evaluate reports. All of the printed laboratory activities are included in Appendix B, and the complete set of rubrics is included in Appendix C.

Graduate student assistants facilitated the laboratory sections with the help of the laboratory preceptor.¹² The laboratory assistants meet weekly with the project management team to learn about the goals and objectives for the laboratory and carry out the experiments themselves.

4.3.2 Measures

This is a mixed-methods study in which we analyzed both quantitative and qualitative data. Quantitative measures included pre- and post-course performance on the Conceptual Survey of Electricity and Magnetism (CSEM) and the Data Handling Diagnostic (DHD), performance on course-related activities (problem sets, laboratory activities, exams and cumulative grades), and rubric-based assessment of exhibition of scientific reasoning abilities in laboratory reports. Additionally, we analyzed pre- and post-course performance on a survey of self-efficacy in physics. Qualitative measures include the summative analysis of students' exhibition of specific scientific reasoning skills over the duration of the semester.

Conceptual Surveys

The CSEM was administered to assess students' conceptual understanding of electrostatics and magnetostatics (Maloney et al., 2001). The survey consists of 32 multiple-choice questions that are designed to elicit students' intuitive ways of thinking – which may or may not be correct –

¹² We note that most of the exploratory activities were under the supervision of one graduate assistant and most of the scaffolded activities were under the supervision of another graduate assistant. A third graduate assistant supervised both laboratories. Although the optimal arrangement would have involved all three assistants in both sequences, we find that results of our analysis persist even when we control for graduate assistant. The laboratory preceptor co-supervised all laboratory sections.

through the use of “everyday” language instead of terminology typical of the physics classroom and response choices that appeal to empirically-identified incorrect ways of reasoning.

The DHD was administered to assess students’ data handling abilities. The survey, consisting of 23 multiple-choice questions, was developed by researchers and instructors at the University of Edinburgh to better understand challenges that students encounter when analyzing and interpreting collected data (Galloway et al., in press). Unlike the FCI and CSEM, the DHD does not avoid language that is typical of these kinds of problems; the goal is not necessarily to evoke a particular way of thinking about the problems, but rather merely to assess student performance on the items.

Both surveys were administered as a pre-course assessment during the first week of the semester and as a post-course assessment sometime after the final class meeting and before the final exam. Both surveys were administered using the Internet-based *Interactive Learning Toolkit*; students had 45 minutes to complete each survey. They received credit for participation, but not for correctness.¹³

Course-Related Performance

If we were to include all of the criteria representing various aspects of students’ performance on course-related activities in our analysis, many of the factors would be redundant. Therefore, we employ the statistical technique of factor analysis to determine if the correlations among different variables actually describe one or more uncorrelated aspects of performance (Costello & Osborne, 2005).

¹³ Based on our analysis in Chapter Two, perhaps we could treat these conceptual surveys as categorical variables. Indeed, this approach has been done by others (Watkins, 2010). However, in our analysis, we are primarily interested in examining students’ pre-course performance, in which there are no ceiling effects. Therefore, we are not inclined to complicate the interpretation of our analysis, while simultaneously suppressing potentially relevant information, if we do not need to do so.

We find that reading exercises (evaluated for participation only), laboratory activities, mid-term exams, final exams and final grades all describe virtually *one* factor; the difference between the first and second eigenvalues is much larger than the differences between subsequent eigenvalues. The final exam and final grade are weighted most heavily in determining that factor. Therefore, for simplicity and clarity, we choose to employ final grade as the primary summative measure of students' performance in the course.

Laboratory grade is not heavily weighted in the factor analysis described above; it is, in fact, rather weak. Moreover, laboratory grades are very highly correlated with our own rubric-based assessment ($r = 0.78$). Therefore, we do not include the "grading" assessment in our analysis and focus on the instead on our own more rigorous, research-driven assessment of the submitted reports.

Scientific Reasoning Abilities

We used the scientific ability rubrics developed for the ISLE curriculum to evaluate students' laboratory reports (Etkina et al., 2006). Each ability is rated on a four-point scale, and each of the four possible ratings includes an explicit statement of the type of student response that would merit that rating. During analysis, we implement the rubrics exactly as they are implemented with the ISLE courses at Rutgers University so that we are able to direct compare the exhibition of scientific abilities among students in *both* sequences of this physics laboratory with previously reported findings. Although there are many differences between the two contexts, the measurement tool is kept constant.

Moreover, we implement these rubrics to ensure that students are evaluated upon their exhibition of the skills of interest, and that students understand the criteria upon which they are

being evaluated. The rubrics employed for research assessment were also used for grading, and they were provided to students with the laboratory activities.^{14,15} All of these materials are included in Appendix B. Assessment for research purposes was conducted independently and blinded from the grading of laboratories for course credit; the degree of rigor is much lower and the time constraints are much higher in the latter case, whereas thoroughness and objectivity are essential in the former case.

Specifically, fifteen scientific abilities were assessed for research purposes. These abilities are summarized in Table 4.1. The ISLE labels correspond to where these abilities appear on the full set of rubrics.

Most of the laboratory activities assess, explicitly or implicitly, all 15 of the scientific reasoning abilities highlighted here; however, some of the activities simply do not require students to exhibit certain abilities. As one might expect, students do not exhibit abilities that are not required (e.g., evaluating uncertainty while conducting qualitative experiments). In such instances, we do not assess students' laboratory reports for exhibition of such abilities. Specifically, we do not assess abilities B2/C2/D2, C4, and F1 in the first laboratory, ability G2 in the fourth laboratory, and abilities C3, C4, and G3 in the fifth laboratory.

For some of the abilities displayed here, the rubrics are very specific – e.g., C8 refers to a “testing” experiment in which a hypothesis is being tested and D4 refers to an “application” experiment in which a particular problem is to be solved or measurement is to be made, but otherwise the skills are very similar – so we collapse these rubrics and apply whichever one is

¹⁴ Students found the complete rubrics used for grading reports from the first three sessions overwhelming and unhelpful. Therefore, we provided less information to students in sessions four and five.

¹⁵ For research purposes, we are interested in the exhibition of several criteria over the course of the semester. Therefore, even though the rubrics used for grading vary over the semester and span many scientific abilities (as the laboratory activities reveal), only 15 specific scientific abilities are investigated here.

more sensible for assessment of a given laboratory activity. This is in keeping with how the rubrics are used for research purposes in previous studies (Karelina, 2011).

Table 4.1: Scientific reasoning abilities. Students' laboratory reports were assessed on the 15 scientific reasoning abilities shown here.

ISLE label	Scientific Reasoning Ability
A3	Is able to evaluate the consistency of different representations and modify them when necessary
B2/C2/D2	Is able to design a reliable experiment
B7	Is able to identify a pattern in the data
B9	Is able to devise an explanation for an observed pattern
B10/C5/D8	Is able to identify the assumptions
C3	Is able to distinguish between a hypothesis and a prediction
C4	Is able to make a reasonable prediction based on a hypothesis
C6/D9	Is able to determine specifically the way in which assumptions might affect the prediction/results
C8/D4	Is able to make a judgment about the hypothesis/results of the experiment
F1	Is able to communicate the details of an experimental procedure clearly and completely
G1	Is able to identify sources of experimental uncertainty
G2	Is able to evaluate specifically how identified experimental uncertainties may affect the data
G3	Is able to describe how to minimize experimental uncertainty and actually do it
G4	Is able to record and represent data in a meaningful way
G5	Is able to analyze data appropriately

Self-Efficacy Survey

This survey, administered as a pre-test during the first week of classes on paper and as a post-test between the last class and the final exam via the Internet, was designed to measure both “physics” self-efficacy and “Peer Instruction” self-efficacy. It was based on a similar survey designed to assess physics self-efficacy (Fencl & Scheel, 2004). Seven of the questions related explicitly to students’ belief in their ability to perform physics-related activities, and eight of the questions related explicitly to students’ belief in their ability to engage in Peer Instruction activities. Students responded to questions on a Likert scale (five-point scale from strongly disagree to strongly agree). Refer to Chapter Three for a much more detailed discussion of self-efficacy.

Although this survey is not directly related to the research questions posed here, we investigate the possibility that different experiences in the laboratory may have different effects on students’ self-efficacy. The survey was implemented both to assess students’ physics self-efficacy and to investigate whether students’ exhibit Peer Instruction self-efficacy. The latter is the subject of ongoing research, so we only consider the first series of questions, related to physics self-efficacy, in our analysis.

4.3.3 Sample Description

Data from 89 students were analyzed, though not all students completed all surveys; response rate information is included in subsequent tables. Table 4.2 displays the descriptive statistics for the CSEM, the DHD, course performance metrics and the physics self-efficacy survey. The mean values of the DHD and physics self-efficacy survey change only slightly over the duration of the semester. The mean CSEM increases from 12.76 to 21.95 on a scale of 0 to 32.

Table 4.2: Descriptive statistics of characteristics of student learning and engagement, Spring 2011.

variable	N	mean	median	s.d.	range
CSEM, pre	72	12.76	12	5.73	2 – 27
CSEM, post	55	21.95	23	6.76	6 – 32
final exam	89	0.70	0.70	0.15	0.33 – 1.00
final grade	89	85.36	86.44	8.76	57.63 – 99.29
DHD, pre	74	12.11	12.5	2.73	4 – 18
DHD, post	53	12.68	13	2.65	6 – 18
self-efficacy, pre	88	3.51	3.57	0.73	1.14 – 5.00
self-efficacy, post	81	3.45	3.43	0.72	1.00 – 5.00

Table 4.3 displays the rating counts of the 15 scientific reasoning abilities highlighted in Table 4.1. These counts are cumulative, summed over the five laboratory activities that students carried out during the semester. Some abilities were not assessed on certain laboratory activities.

Table 4.3: Exhibition of scientific reasoning abilities, Spring 2011. The cumulative rating counts, summed over the five laboratory activities, of each of the 15 scientific reasoning abilities of interest are shown here.

Ability	0	1	2	3
Is able to evaluate the consistency of different representations and modify them when necessary	0	3	47	81
Is able to design a reliable experiment	0	1	26	77
Is able to identify a pattern in the data	0	7	27	97
Is able to devise an explanation for an observed pattern	16	31	15	69

Table 4.3 (continued)

Ability	0	1	2	3
Is able to identify the assumptions	26	29	50	26
Is able to distinguish between a hypothesis and a prediction	0	40	10	57
Is able to make a reasonable prediction based on a hypothesis	0	6	15	59
Is able to determine specifically the way in which assumptions might affect the prediction/results	57	34	30	10
Is able to make a judgment about the hypothesis/results of the experiment	1	9	62	59
Is able to communicate the details of an experimental procedure clearly and completely	1	7	58	38
Is able to identify sources of experimental uncertainty	22	28	28	53
Is able to evaluate specifically how identified experimental uncertainties may affect the data	41	29	14	20
Is able to describe how to minimize experimental uncertainty and actually do it	55	11	9	32
Is able to record and represent data in a meaningful way	4	24	39	64
Is able to analyze data appropriately	1	11	73	46

4.3.4 Analytic Methods

We investigated the relationships among these factors using *t*-tests and chi-square tests. We are primarily interested in comparing students in the exploratory, SCL-like sequence to students in the heuristically scaffolded ISLE design-like sequence. Therefore, for the continuous variables displayed in Table 4.2, the *t*-test is the appropriate method of comparison.

The discrete ratings of scientific abilities present a different challenge. Formally, the chi-square test is better-suited for comparisons involving scientific abilities because, although the

ratings scale from zero to three, nothing about the ratings suggests that they should be exactly one unit apart from one another. The different ratings might as well be represented by shapes or colors instead of numbers. However, the chi-square test requires that the expected count in each cell be at least five (Moore et al., 2008), which is not necessarily true. Therefore, we address the problems by two means: (1) we assume that ratings are, in fact, one unit apart from one another and employ *t*-tests and (2) we merge ratings that contain fewer than five counts with neighboring ratings and employ chi-square tests. Both methods are reported below.^{16,17}

We do not employ statistics in our analysis of changes in individual scientific reasoning abilities over the duration of the semester. We would almost certainly measure some statistically significant differences across the five sessions, but such differences are not as informative as the objective, qualitative analysis of the time evolution of the exhibition of specific reasoning abilities.

Two researchers independently coded students' submitted laboratory reports and subsequently discussed coding. All discrepancies were resolved during discussion, and the rubric criteria were further defined to eliminate future discrepancies. Once the criteria were sufficiently well established through discussion, remaining reports were coded independently.

¹⁶ We note that when we group all the students' submitted reports together for analysis, we are counting multiple reports from the same individuals as independent data. Reports were submitted by *groups* of students, and these groups varied from session to session, but ultimately the same groups of students contributed reports on five distinct occasions. Because groups varied, we cannot calculate semester-long averages by groups of students. However, we also cannot assess each session independently because of the count requirements for chi-square analysis. Therefore, we cautiously acknowledge the potential for artificially *improved* statistical power, though we also highlight the variations between labs and between groups that may mitigate such effects. Also, as our results show, almost none of the comparisons reveal statistically significant differences.

¹⁷ We note that, in comparing so many scientific abilities, the likelihood of a spurious yet statistically significant difference is not negligible. The Bonferroni correction, which depresses the threshold for statistical significance when multiple comparisons are being analyzed, would help prevent this. However, as we shall see, virtually all of the comparisons are *not* significant (and the one comparison that is significant is *very* significant). Therefore, we acknowledge the correction technique but forgo discussion as it is not necessary in our analysis.

As mentioned, we employ factor analysis techniques to establish which course performance measures should be used for analysis.

4.4 Results

The present analysis branches in two primary directions: (1) comparison of exploratory and scaffolded laboratory sequences to one another and (2) investigation of the exhibition of scientific reasoning abilities over the duration of the semester. These two branches are not entirely separate from one another, as described below.

4.4.1 Comparison of Exploratory and Scaffolded Sequences

As the two sequences are distinct only after the second laboratory session, only laboratory sessions three, four and five are considered in the following comparisons.¹⁸

Table 4.4 summarizes the comparisons between the exploratory, SCL-like sequence of laboratory activities (“e”) and the heuristically scaffolded, ISLE design-like sequence of laboratory activities (“s”). The former is displayed in the top row of each comparison and the latter is displayed in the bottom row.

We see that only the DHD post-test is statistically significantly different between the two groups; students in the exploratory sequence demonstrated modest gains, while students in the scaffolded sequence exhibited modest losses. No other metrics reveal statistically significant differences.

¹⁸ Although the fifth laboratory is the same in both sequences, students did not attend sections with students from the other sequence in order to allow us to distinguish between the groups through the end of the course.

Table 4.4: Comparison of exploratory and scaffolded laboratory sequences by characteristics of student learning and engagement. The top row of each comparison displays statistics from the exploratory, SCL-like sequence, and the bottom row displays statistics from the scaffolded, ISLE design-like sequence.

variable	sequence	N	mean	median	s.d.	range	<i>t</i> -test <i>p</i> value
CSEM, pre	e	38	12.03	12	5.08	3 – 26	0.257
	s	34	13.59	14	6.35	2 – 27	
CSEM, post	e	31	23.06	23	5.55	6 – 31	0.186
	s	24	20.5	22.5	7.95	6 – 32	
final exam	e	47	0.71	0.70	0.13	0.37 – 1.00	0.565
	s	42	0.69	0.69	0.17	0.33 – 0.98	
final grade	e	47	86.04	86.44	8.13	59.98 – 99.29	0.443
	s	42	84.59	86.55	9.46	57.63 – 99.53	
DHD, pre	e	40	12.13	13	2.61	5 – 18	0.955
	s	34	12.09	12	2.90	4 – 17	
DHD, post	e	29	13.45	14	2.31	7 – 18	0.021*
	s	24	11.75	12	2.79	6 – 16	
self-efficacy, pre	e	47	3.53	3.57	0.72	2.00 – 4.86	0.730
	s	41	3.48	3.43	0.75	1.14 – 5.00	
self-efficacy, post	e	44	3.55	3.64	0.67	2.29 – 4.86	0.159
	s	37	3.32	3.29	0.77	1.00 – 5.00	

(**p* < 0.05, ***p* < 0.01, ****p* < 0.001)

Table 4.5 summarizes the comparisons between the two sequences in the 15 scientific reasoning abilities described above. The vertical lines separating some rating scores from others represent the bins used to perform chi-square tests.

Table 4.5: Comparison of exploratory and scaffolded sequences by scientific reasoning abilities. The top row of each comparison displays statistics from the exploratory sequence, and the bottom row displays statistics from the scaffolded sequence. The vertical lines separating some rating scores from others represent the bins used to perform chi-square tests.

ability	seq	0	1	2	3	chi-square p	avg	t -test p
Is able to evaluate the consistency of different representations and modify them when necessary	e	0	1	16	23	0.323	2.55	0.255
	s	0	0	11	24		2.69	
Is able to design a reliable experiment	e	0	0	12	28	0.513	2.70	0.403
	s	0	1	12	22		2.60	
Is able to identify a pattern in the data	e	0	1	3	36	n.a.	2.88	0.839
	s	0	0	5	30		2.86	
Is able to devise an explanation for an observed pattern	e	4	9	4	23	0.921	2.15	0.721
	s	5	6	6	18		2.06	
Is able to identify the assumptions	e	1	10	20	9	0.645	1.93	0.572
	s	2	6	23	4		1.83	
Is able to distinguish between a hypothesis and a prediction	e	0	5	2	20	0.234	2.56	0.175
	s	0	9	1	14		2.21	
Is able to make a reasonable prediction based on a hypothesis	e	0	1	4	22	0.129	2.78	0.213
	s	0	1	8	15		2.58	

(* $p < 0.05$, ** $p < 0.01$, *** $p < 0.001$)

Table 4.5 (continued)

ability	seq	0	1	2	3	chi-square p	avg	t -test p
Is able to determine specifically the way in which assumptions might affect the prediction/results	e	7	13	18	2	0.155	1.38	0.455
	s	13	8	8	6			
Is able to make a judgment about the hypothesis/results of the experiment	e	0	0	14	26	0.345	2.65	0.158
	s	0	3	13	19			
Is able to communicate the details of an experimental procedure clearly and completely	e	1	3	25	11	0.372	2.15	0.485
	s	0	4	18	13			
Is able to identify sources of experimental uncertainty	e	2	4	10	24	0.312	2.40	0.157
	s	3	7	9	16			
Is able to evaluate specifically how identified experimental uncertainties may affect the data	e	5	7	2	12	0.562	1.81	0.811
	s	2	10	2	8			
Is able to describe how to minimize experimental uncertainty and actually do it	e	8	0	2	17	0.000***	2.04	0.001***
	s	14	5	2	3			
Is able to record and represent data in a meaningful way	e	1	5	8	26	0.479	2.48	0.233
	s	2	6	9	18			

(* $p < 0.05$, ** $p < 0.01$, *** $p < 0.001$)

Table 4.5 (continued)

ability	seq	0	1	2	3	chi-square p	avg	t -test p
Is able to analyze data appropriately	e	0	0	21	19		2.48	
	s	1	1	15	18	0.734	2.43	0.746

(* $p < 0.05$, ** $p < 0.01$, *** $p < 0.001$)

We see that only the ability to minimize uncertainty differs statistically significantly between the two groups. All of the other abilities are indistinguishable between the two groups.

In Table 4.5, the three laboratory sessions under consideration are combined together so that we can investigate individual scientific reasoning abilities. Without combining them, the numbers in each category are insufficient for statistical analysis. Alternatively, we can combine ratings of scientific abilities into a cumulative score and compare exploratory and scaffolded sequences across different laboratory sessions. These results are displayed in Table 4.6.

Table 4.6: Comparison of exploratory and scaffolded sequences by laboratory.

variable	Exploratory	N	SE	Scaffolded	N	SE	t-test <i>p</i> value
Lab 3	34.77	13	1.20	31.45	11	1.15	0.060
Lab 4	33.07	14	1.01	28.77	13	1.32	0.017*
Lab 5	27.69	13	1.10	28.64	11	1.12	0.554
Total	31.88	40	0.78	29.57	35	0.72	0.035*

(**p* < 0.05, ***p* < 0.01, ****p* < 0.001)

Students' cumulative exhibition of scientific reasoning abilities in the exploratory sequence is marginally significantly better in the third session and significantly better in the fourth session. When students from both sequences engage with the exploratory activities in the fifth session, the difference vanishes.

4.4.2 Scientific Reasoning Abilities over Time

The assessment methods employed here are well suited for investigation of the acquisition of scientific reasoning skills, regardless of which sequence of activities in which students engaged.

We focus on five of the scientific reasoning abilities discussed above to better understand how student exhibition of these abilities changes over the duration of the semester. The five abilities are: (1) the ability to devise an explanation for an observed pattern, (2) the ability to identify the assumptions, (3) the ability to determine specifically the way in which assumptions might affect the prediction/results, (4) the ability to identify sources of experimental uncertainty and (5) the ability to evaluate specifically how identified experimental uncertainties may affect the data. We select these five abilities not only because they afford us insights into student engagement, but also because they afford us the capacity to compare these students' exhibition of these abilities – or lack thereof – to that of students from other institutions where analogous studies have been conducted (Deardorff, 2001; Etkina et al., 2006, 2010, 2008; Lippmann, 2003). Data are presented here; comparisons are discussed in the subsequent section.

Figure 4.2 is the first of five figures designed to display the exhibition of scientific reasoning abilities over the duration of the semester. Each color represents a different rating, and the width of each color represents the fraction of the number of labs submitted that received that rating. The five bi-weekly labs are represented along the descending vertical axis. Even though differences between the exploratory and scaffolded sequences are not the primary focus here, the groups are visually represented by striped and solid bars, respectively, for the third, fourth and fifth laboratory sessions.

Figure 4.2 displays students' ability to devise an explanation for an observed pattern. Students do not exhibit this ability very strongly in their reports from the first session; however, this is in keeping with other abilities, as students generally responded to discussion questions with very short answers and limited explanations. We cannot determine whether this resulted from the step-by-step instructional format of the activities or the mismatch between students'

expectations and the novel approach to assessment. In the second session, students demonstrated the ability much more clearly. In the third session, which was the first time that the ability was not explicitly stated as part of the assessment criteria for the reports, students' exhibition of the activity declined. The pattern repeats through the fourth and fifth sessions, when the ability once again reappears and then disappears as part of the explicit assessment criteria. This suggests that students' demonstration of this ability, although strong, is not sustained when the ability is not emphasized.

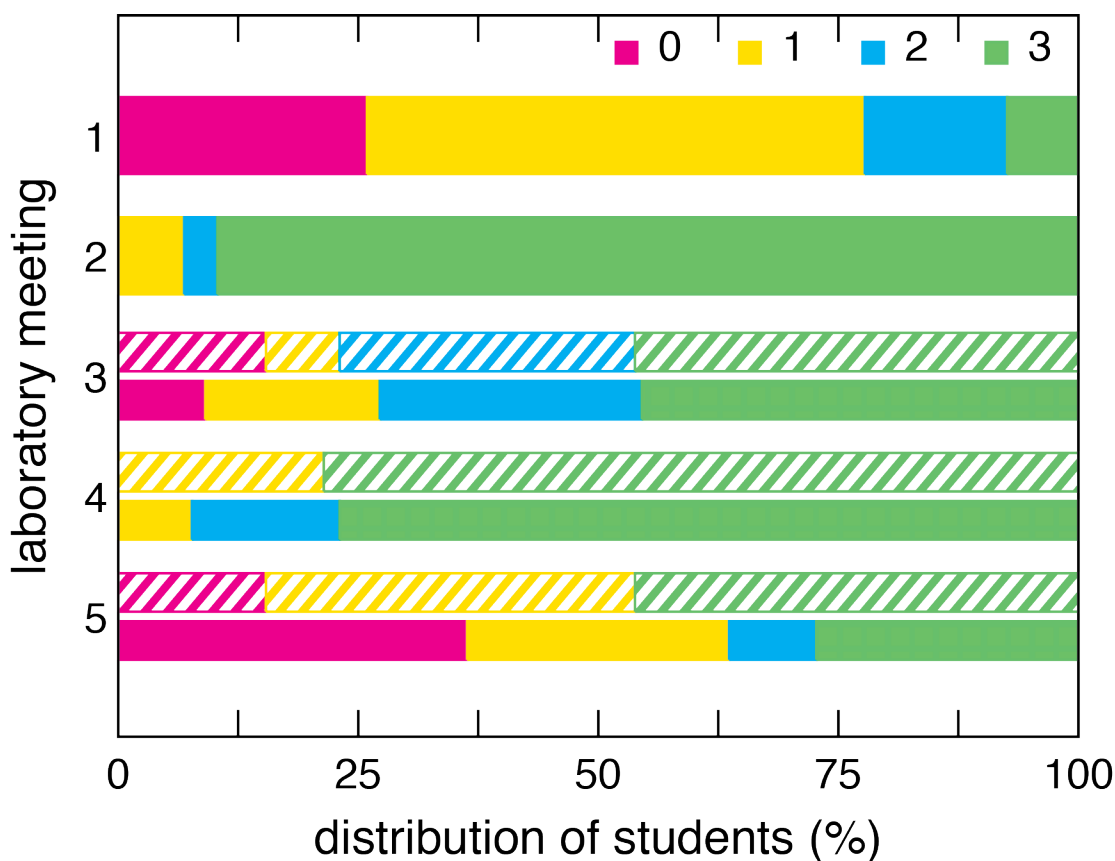

Figure 4.2: Students' ability to devise an explanation for an observed pattern ($N_{\text{report}} = 131$). Each color represents a different rubric score, and the width of each color represents the fraction of the number of labs submitted that received that rubric score. Striped bars represent exploratory sequence labs and solid bars represent scaffolded sequence labs.

The ability to identify assumptions that are made when making observations, testing a hypothesis or solving a problem in the laboratory is one of several important abilities that students struggle to exhibit consistently (Etkina et al., 2010, 2008). As shown in Figure 4.3, students do not exhibit the ability in reports from the first session, improve substantially in reports from the second session, but then appear to plateau – or perhaps even regress – in reports from subsequent sessions. Students tend to list several general assumptions rather than considering factors that actually could affect the experiment if they are not as assumed.

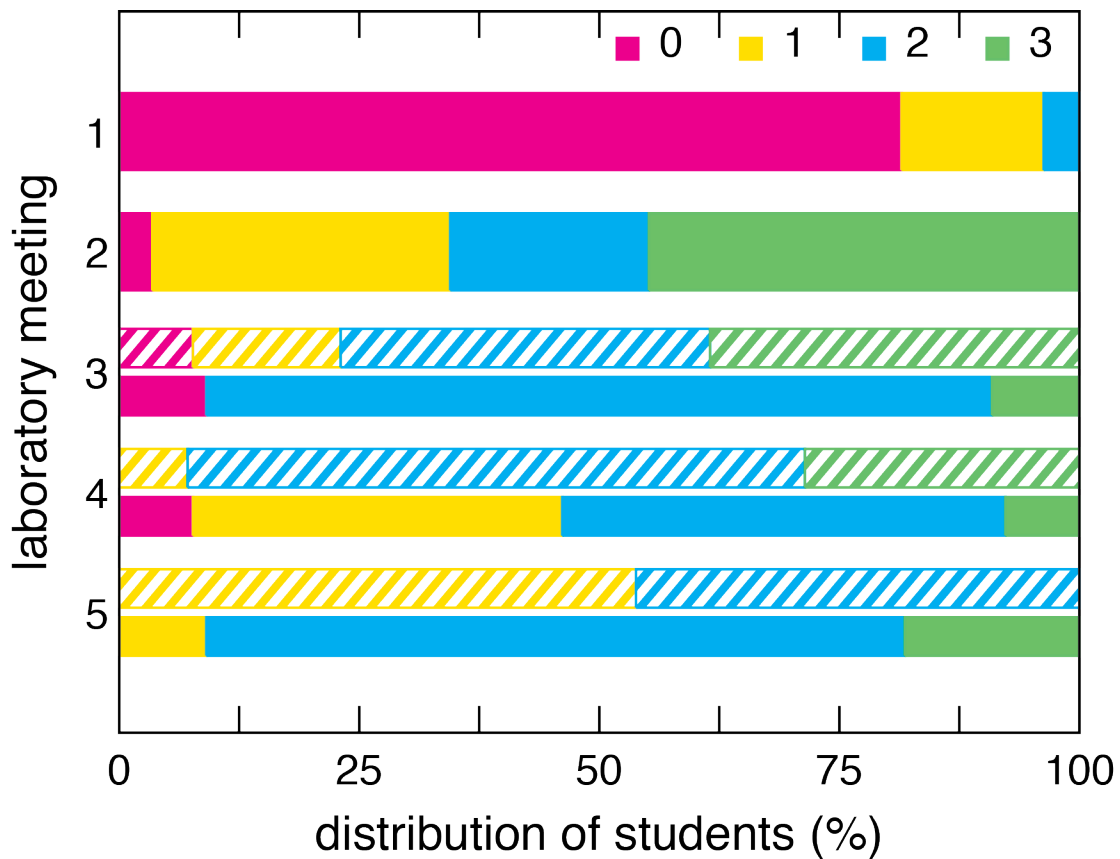

Figure 4.3: Students' ability to identify assumptions ($N_{\text{report}} = 131$). Each color represents a different rubric score, and the width of each color represents the fraction of the number of labs submitted that received that rubric score. Striped bars represent exploratory sequence labs and solid bars represent scaffolded sequence labs.

Even more complex than the ability to identify assumptions is the ability to determine the effects of assumptions; students exhibit this ability when they go beyond merely stating the necessary assumptions and actually describe how such factors, were they not as assumed, would affect the experiment. Figure 4.4 highlights the fact that students struggle with this ability throughout the course. They steadily improve in their ability to identify the effects (which is rated at “2”), but struggle immensely with taking the next step and validating the assumptions.

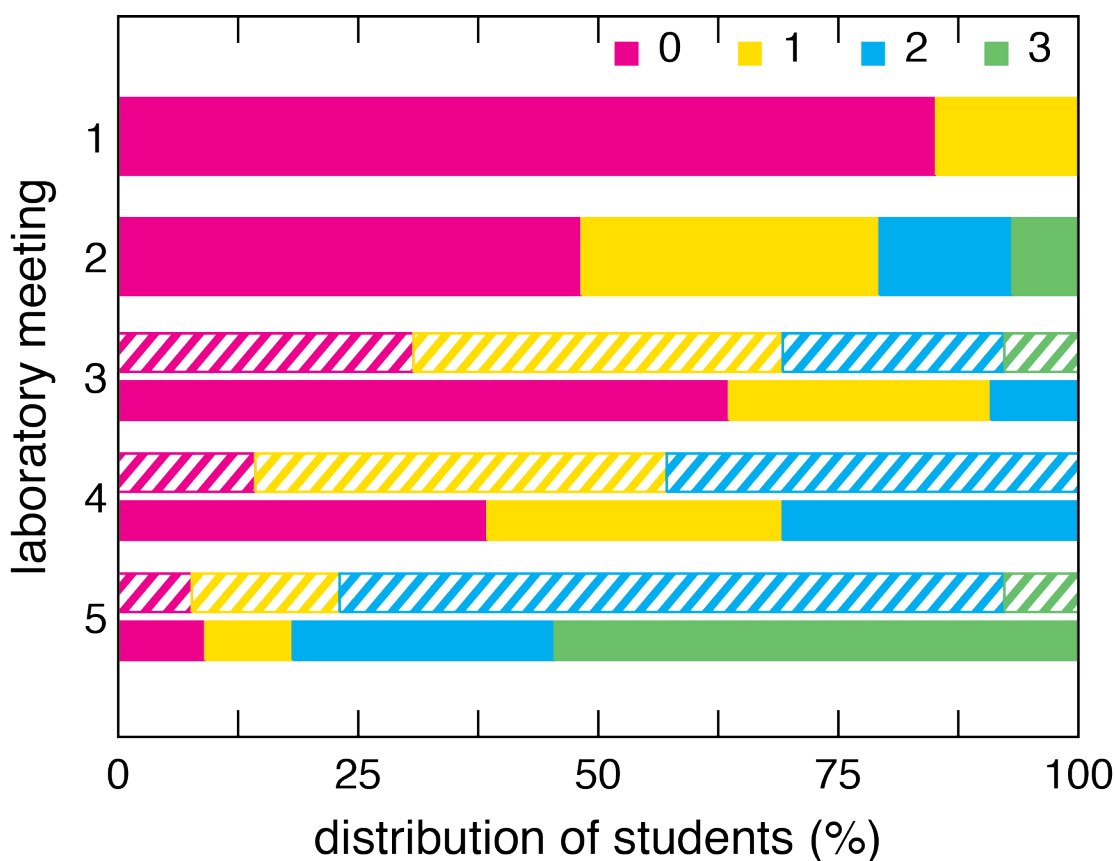

Figure 4.4: Students’ ability to determine specifically the way in which assumptions might affect the prediction/results ($N_{\text{report}} = 131$). Each color represents a different rubric score, and the width of each color represents the fraction of the number of labs submitted that received that rubric score. Striped bars represent exploratory sequence labs and solid bars represent scaffolded sequence labs.

Another area in which students' struggles are well documented involves the identification and calculation of measurement uncertainty (Deardorff, 2001; Etkina et al., 2006, 2010, 2008; Kung, 2005; Lippmann, 2003). Figure 4.5 displays how students' ability to identify sources of experimental uncertainty change throughout the semester. Students demonstrate improvement with every subsequent session, but exhibition of the ability appears to plateau before saturation. Just as some students list general assumptions, students tend to list vague and general sources of uncertainty instead of focusing on the measurements involved in the experiment.

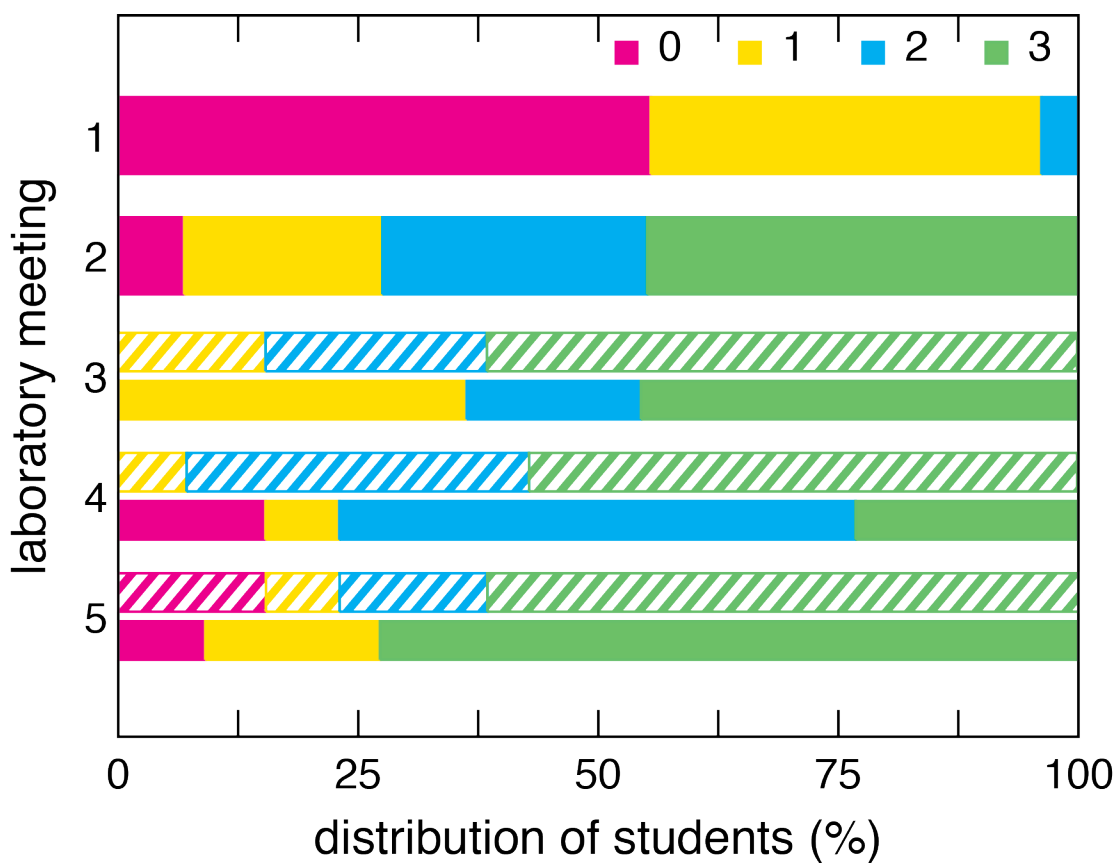

Figure 4.5: Students' ability to identify sources of experimental uncertainty ($N_{\text{report}} = 131$). Each color represents a different rubric score, and the width of each color represents the fraction of the number of labs submitted that received that rubric score. Striped bars represent exploratory sequence labs and solid bars represent scaffolded sequence labs.

Also, students struggle with distinguishing between assumptions – elements of the environment or apparatus that can be considered negligible, constant or predictable – and sources of uncertainty – measurements of attributes or quantities that have some finite accuracy and precision. Often students confuse the two concepts or simply pool them together. The ability to distinguish between assumptions and uncertainties, however, is not formally assessed.

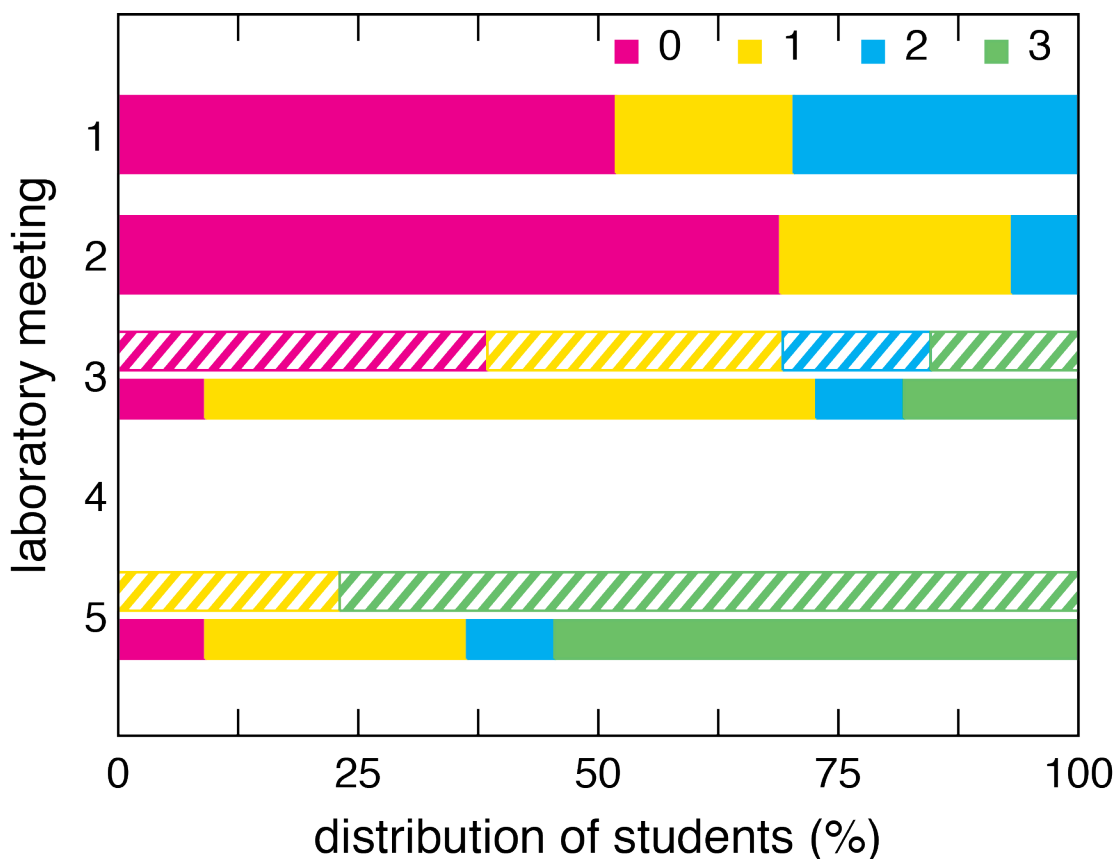

Figure 4.6: Students’ ability to evaluate specifically how identified experimental uncertainties may affect the data ($N_{\text{report}} = 104$). Each color represents a different rubric score, and the width of each color represents the fraction of the number of labs submitted that received that rubric score. Striped bars represent exploratory sequence labs and solid bars represent scaffolded sequence labs. This ability was not required in activities from the fourth session, so no data are recorded.

Finally, we highlight students’ ability to evaluate specifically how identified experimental uncertainties may affect the data in Figure 4.6. This is more difficult than merely identifying

uncertainties, as demonstrated by the low ratings through the reports from the first three sessions. Reports from the fourth session are not included here because the experiments were almost entirely qualitative in nature; students made observations and collected data, but the sources of uncertainty were not quantifiable. Students showed much stronger abilities in reports from the fifth session, though their use of linear regression techniques in this particular activity made evaluation of error somewhat different – and, perhaps, more straightforward – than in prior activities.

Students improve throughout the semester in many of the abilities that we assess. Nonetheless, at the end of the semester, they do not saturate some of these abilities involving uncertainty and assumption that are very closely tied to the goals of the instructional laboratory.

4.5 Discussion

Just as the results presented above branch in two main directions, we discuss each one of these branches below. We then connect our findings to the theoretical elements of transfer, address the limitations of this work and suggest potential future directions.

4.5.1 Comparison of Exploratory and Scaffolded Sequences

The comparative analysis of students from two sequences of laboratory activities, one that is more exploratory and another that is more explicitly scaffolded, indicates that there are differences between the two groups, although the differences are slight. Students engaged in the exploratory, SCL-like sequence exhibit better scientific reasoning and data handling abilities.

Among surveys and course performance metrics, only the post-course DHD reveals a statistically significant difference between the groups. No single item on the 23-question survey

is associated with this difference. However, the difference between the two groups in *actual* units is only 1.7 questions. Perhaps it is not surprising that both groups performed relatively poorly, as the laboratory activities were not explicitly designed to improve performance on the DHD. Many of the questions on the survey require students to utilize specific knowledge and strategies, whereas the laboratory activities attempt to engender and promote scientific ways of thinking. In other words, the DHD is focused on a dimension of learning that seems to be orthogonal to the dimensions that are central to the design of the laboratory sequences. So, while this relationship may be suggestive of potentially larger differences in an untapped dimension of student learning, the slight difference is not especially meaningful by itself.

Unlike the DHD, the scientific reasoning abilities are precisely aligned with the learning goals in the laboratory. We once again measure almost no differences between the two sequences across many of the abilities assessed. However, the strongly statistically significant difference between students from each sequence in their ability to minimize uncertainty may reveal information about the roots of the persistent slight differences. The freedom afforded to students in the exploratory sequence may allow them to design and conduct experiments with which *they* feel the most comfortable engaging. The heuristically scaffolded activities require students to occasionally address questions that challenge their expectations about what a solution might look like. Minimizing uncertainty, for instance, is easier to think about when an experiment results in a quantitative value that can be averaged over multiple trials. If the experiment is qualitative, considering and minimizing uncertainty are not necessarily so familiar to students.

Overall, less scaffolding is associated with slightly improved *exhibition* of scientific reasoning abilities. This may result from students engaging more critically throughout the activities, or it may result from students choosing the path about which they are more

comfortable and confident. The latter cause doesn't necessarily mean that the exploratory approach is weaker; as we discussed extensively in Chapter Three, confidence and self-efficacy are strongly associated with positive learning outcomes. Perhaps the fact that the reports from the two sequences are indistinguishable in the fifth laboratory meeting suggests that the slight differences are superficial (though we must be careful not to draw conclusions from a single laboratory activity).

Practically speaking, as the differences in all facets of assessment are quite small, there is no evidence to suggest that either sequence is better or worse than the other according to the metrics assessed here. Others report that *both* of these approaches promote stronger exhibition of scientific reasoning skills and time spent sense-making than traditional laboratories (Etkina et al., 2010; Lippmann, 2003); therefore, our findings suggest that both approaches are viable alternatives for laboratory instruction.

4.5.2 Scientific Reasoning Abilities over Time

Some skills, such as the ability to evaluate the consistency of different representations, the ability to design a reliable experiment and the ability to make a reasonable prediction based on a hypothesis, seem to saturate early in the semester and remain saturated throughout. Other skills, such as those displayed in Figure 4.2, Figure 4.3 and Figure 4.5, either plateau or decline throughout the semester. Still others, such as those displayed in Figure 4.4 and Figure 4.6, increase throughout the semester but do not saturate.

These observations suggest that, regarding many of the scientific reasoning abilities of interest, five bi-weekly laboratory sessions are not sufficient for acquisition. Etkina and colleagues report that only after eight *weekly* sessions in which students conduct heuristically

scaffolded design laboratories do they begin to achieve mastery of scientific abilities (Etkina et al., 2008). We cannot determine whether the amount of time, number of meetings, frequency of meetings, or the combination of these factors accounts for their observation. Nonetheless, our findings suggest that fewer meetings at a lower frequency, in spite of differences in student population, are not as effective as activities conducted elsewhere. More opportunities for students to engage in laboratory activities allow for (1) longer duration of scaffolding, (2) more *varied* scaffolding and (3) more *distributed* scaffolding; in spite of the fact that only a fraction of the scientific reasoning abilities were incorporated for assessment, students were clearly overwhelmed by the information.

4.5.3 Transfer

As mentioned before, in linking transfer to teaching practices, Georghiades highlights metacognition, and specifically metacognitive activities together with social activities, as a way of overcoming the decay in conceptual change (Georghiades, 2000). This notion applies to *both* the exploratory, SCL-like sequence of laboratory activities and the heuristically scaffolded, ISLE design-like sequence, and it may also suggest an alternative explanation for why the differences between the two sequences are so slight. The heuristic scaffolding, while not explicitly metacognitive, provides a template for the kinds of questions students can ask themselves later, in a less scaffolded environment; in other words, the scaffolding is a template for metacognition. The exploratory activities, although not explicitly scaffolded, promote extensive interaction among students. So it is perhaps a misnomer to suggest that only one sequence is scaffolded; both are scaffolded in such ways as to emphasize different aspects of learning.

Explicitly regarding transfer, Lobato discusses three key mechanisms: (1) “focusing phenomena,” features in a classroom environment that direct students’ attention toward certain properties or patterns, (2) “social framing,” a way of framing both activities and students’ roles as being connected with other contexts in which the learning experiences are relevant, and (3) “discernment of differences,” in which students consider differences between situations to ultimately refine transfer ability (Lobato, 2006). In these laboratory sessions, the focusing phenomena are the activities; the printed materials are designed to consistently focus students on the relevant goals and scientific abilities from session to session, even as the content-related aspects of the activities change. Social framing occurs as students return to the same room, sometimes reforming the same group, to engage in these activities; the expectations for the various interactions that take place – among students as they discuss the activities, between instructors and students, and even among the whole class – are consistent from session to session, and therefore reinforce the reasoning skills that are associated with those interactions. Although the discernment of differences is not explicitly reinforced, the different ways in which scientific reasoning skills are applied from one activity to the next require students to consider such differences. Thus, all three of these features play an important role in the activities studied here.

4.5.4 Limitations

Although we were able to access many dimensions of student learning and engagement in the introductory physics laboratory, we note some specific limitations.

With only five bi-weekly meetings, we cannot conclusively establish whether differences – or the lack thereof – between groups or from one session to the next result from underlying

trends or unrelated fluctuations. For example, perhaps the difference in exhibited abilities between students from the two sequences in the fifth session disappears because the groups are not actually different, or perhaps it disappears because those specific activities happen to mask the actual differences. Even if there were ten labs, however, I doubt we would have chosen to implement multiple overlapping activities. One way to overcome this limitation is to continue conducting studies like this in different courses and different institutions until the amount of data suppresses the noise enough for underlying trends to emerge. Alternatively, we can conduct more extensive qualitative analysis of students' reasoning to better understand how the intricacies of each specific laboratory session might affect our conclusions. This may be the more fruitful of the two alternatives, as the system is very complicated and not thoroughly understood.

Although we could not implement video recordings for discourse analysis as a component of this study, such data could certainly inform the question of whether students in the exploratory sequence exhibit stronger reasoning abilities because they are more inclined to make choices about which they are confident or because they are more critically engaged. This remains an open question for future investigation.

4.6 Conclusion

Ultimately, we find that students who engage in two different sequences of laboratory activities – exploratory and heuristically scaffolded – both demonstrate similarly enhanced scientific reasoning skills; the students who participate in the former sequence slightly outperform those in the latter, though perhaps the difference in performance only occur while the groups are engaging in different activities, as it disappears when the two groups engage in identical final

laboratory activities. Regardless of group, some important skills are either not exhibited or retained by many of the students, suggesting that five bi-weekly meetings are not sufficient for acquisition and demonstration of these abilities.

Chapter Five

Conclusions

At the end of Chapter One, we suggest that the best forms of assessment collect as much information as possible about student learning outcomes, but the interpretation of that information is essential. Each of the projects described in this work represent our efforts to exemplify this statement through physics education research.

Here we review the conclusions drawn from the three preceding chapters and elaborate on the common theme of assessment from the instructor's perspective.

5.1 Review

In Chapter Two, we describe the challenges that instructors may encounter when attempting to interpret results after implementing the Force Concept Inventory (FCI). To solve these challenges, we introduce *stratagrams*: simple visualizations of student performance that highlight the rate of students becoming Newtonian thinkers, and therefore provide a clear, informative basis for both assessing a single class and comparing performance between a small number of classes. Whereas normalized gain, the standard metric of success on the FCI, is certainly useful when many different classes are involved, data show that several factors, particularly losses and differences in pre-test performance, complicate the interpretation of normalized gain when it is used to compare FCI performance between small numbers of classes. In such comparisons, fluctuations among different calculations of normalized gain are not negligible and can significantly affect the outcome. Moreover, none of the variations of normalized gain address the fact that users of normalized gain cannot say which students in the class are improving, and none of them highlight differences in student population. Thus, stratagrams fill an instructive, accessible and previously unexplored niche in the array of tools that are available to instructors for learning the most from student performance on the FCI, as well as other similar pre-test and post-test conceptual inventories.

In Chapter Three, we find that students' expressions of confusion transect many different dimensions of performance, attitude and identity. Students who express more confusion tend to also express lower confidence, lower self-efficacy, and, to a slight degree, weaker performance on reading exercises. However, when we control for all of these factors, students who express confusion tend to also perform better overall, as measured by final grade. Thus, we suggest that,

when relevant factors are *not* controlled for, expressions of confusion may be either bad or merely uninformative; but when relevant factors *are* controlled for, assuming that we are interested in relating assessment of confusion to final grades, confusion is good. In other words, we are able to identify and isolate the productive role of confusion using surveys and reading assignment activities that are entirely accessible to instructors. Thus, if instructors assess confusion as presented here, then they can monitor the productive role of confusion, assess students' metacognition as they engage in activities, and perhaps even find ways to promote such constructive expressions of confusion.

Finally, in Chapter Four, we explore students' exhibition of scientific reasoning abilities in the introductory physics laboratory. We find that students who engage in two different sequences of laboratory activities – exploratory and heuristically scaffolded – both demonstrate similarly enhanced scientific reasoning skills; the students who participate in the former sequence slightly outperform those in the latter, though perhaps the difference in performance only occur while the groups are engaging in different activities, as it disappears when the two groups engage in identical final laboratory activities. Practically speaking, as the differences in all facets of assessment are quite small, there is no evidence to suggest that either sequence is better or worse than the other according to the metrics assessed here. Others report that *both* of these approaches promote stronger exhibition of scientific reasoning skills and time spent sense-making than traditional laboratories (Etkina et al., 2010; Lippmann, 2003); therefore, our findings suggest that both approaches are viable alternatives for laboratory instruction. Regardless of group, though, some important skills are either not exhibited or retained by many of the students, which suggests that five bi-weekly meetings are not sufficient for acquisition and demonstration of the most important abilities. More opportunities for students to engage in laboratory activities allow

for (1) longer duration of scaffolding, (2) more *varied* scaffolding and (3) more *distributed* scaffolding.

In spite of the differences in scope, context and analytical techniques, these three projects are all driven by the motivation to better design, understand and implement *assessment* to improve students' learning and engagement in physics. Stratagrams incorporate the intended goals of the FCI into a precise means of assessing the performance of a class. We better understand confusion as a means of assessing both positive and negative ways in which students think and feel about physics, and how that relates to success in physics. Using carefully designed rubrics for assessment of scientific reasoning, we can make clear statements about pedagogical approaches to laboratory instruction and implement changes based on those assessments.

In short, we present insights into three unique and important avenues of assessment in the physics classroom and laboratory through extensive data collection and close inspection of the underlying relationships.

5.2 The Goal of Assessment

Even though the focus of this work is assessment, the *first* step in the instructional process should always be the determination of goals (Wiggins, 2005). One cannot assess FCI performance without first establishing our goal in administering the survey. One cannot assess the role of students' expressions of confusion, or the value of that role, without first determining which outcomes are considered positive, negative or neutral. We cannot assess the effectiveness of alternate approaches to laboratory instruction without first establishing the goals of laboratory instruction. Once the goals are established, assessment is simply a matter of determining the proper questions to pose and interpreting what different answers could mean.

Building from goal to assessment, and then towards instruction, captures the essence of *Understanding by Design* (Wiggins, 2005). Regarding assessment, they write:

We are obligated to consider the assessment evidence implied by the outcomes sought, rather than thinking about assessment primarily as a means for generating grades. Given the goals, what performance evidence signifies that they have been met? Given the essential questions, what evidence would show that the learner had deeply considered them? Given the understandings, what would show that the learner “got it”? We urge teachers to consider a judicial analogy as they plan assessment. Think of students as juries think of the accused: innocent (of understanding, skill, and so on) until proven guilty by a preponderance of evidence that is more than circumstantial. (p. 148)

We hope that the work presented here, in addition to abiding by the criteria described, sheds some light on the ways in which instructors can use such tools in physics classrooms and instructional laboratories.

References

- Adams, W. K., Perkins, K. K., Podolefsky, N. S., Dubson, M., Finkelstein, N. D., & Wieman, C. E. (2006). New instrument for measuring student beliefs about physics and learning physics: The Colorado Learning Attitudes about Science Survey. *Physical Review Special Topics - Physics Education Research*, 2(1), 010101. doi:10.1103/PhysRevSTPER.2.010101
- Adams, Wendy K, Paulson, A., & Wieman, C. E. (2008). What Levels of Guidance Promote Engaged Exploration with Interactive Simulations? *AIP Conference Proceedings*, 1064(1), 59–62. doi:10.1063/1.3021273
- Andrew, S. (1998). Self-efficacy as a predictor of academic performance in science. *Journal of Advanced Nursing*, 27(3), 596–603. doi:10.1046/j.1365-2648.1998.00550.x
- Antti Savinainen and Philip Scott. (2002). The Force Concept Inventory: a tool for monitoring student learning. *Physics Education*, 37(1), 45.
- Bandura, A. (1977). Self-efficacy: Toward a unifying theory of behavioral change. *Psychological Review*, 84(2), 191–215. doi:10.1037/0033-295X.84.2.191
- Bandura, A. (1986). The Explanatory and Predictive Scope of Self-Efficacy Theory. *Journal of Social and Clinical Psychology*, 4(3), 359–373. doi:10.1521/jscp.1986.4.3.359
- Bandura, A. (1989). Human agency in social cognitive theory. *American Psychologist*, 44(9), 1175–1184. doi:10.1037/0003-066X.44.9.1175
- Bao, L. (2006). Theoretical comparisons of average normalized gain calculations. *American Journal of Physics*, 74(10), 917. doi:10.1119/1.2213632
- Bao, L., & Redish, E. F. (2006). Model analysis: Representing and assessing the dynamics of student learning. *Physical Review Special Topics - Physics Education Research*, 2(1), 010103.
- Barnett, S. M., & Ceci, S. J. (2002). When and where do we apply what we learn?: A taxonomy for far transfer. *Psychological Bulletin*, 128(4), 612–637. doi:10.1037/0033-2909.128.4.612
- Barrow, L. (2006). A Brief History of Inquiry: From Dewey to Standards. *Journal of Science Teacher Education*, 17(3), 265–278. doi:10.1007/s10972-006-9008-5
- Bransford, J. D., Brown, A. L., & Cocking, R. R. (Eds.). (2000). *How people learn: Brain, mind, experience, and school: Expanded Edition*. Washington, DC: National Academy Press.
- Carraher, D., & Schliemann, A. (2002). The Transfer Dilemma. *Journal of the Learning Sciences*, 11(1), 1–24. doi:10.1207/S15327809JLS1101_1

- Cheng, K. K., Thacker, B. A., Cardenas, R. L., & Crouch, C. (2004). Using an online homework system enhances students' learning of physics concepts in an introductory physics course. *American Journal of Physics*, 72(11), 1447. doi:10.1119/1.1768555
- Cobb, P., & Bowers, J. (1999). Cognitive and Situated Learning Perspectives in Theory and Practice. *Educational Researcher*, 28(2), 4–15. doi:10.3102/0013189X028002004
- Coletta, V. P., & Phillips, J. A. (2005). Interpreting FCI scores: Normalized gain, preinstruction scores, and scientific reasoning ability. *American Journal of Physics*, 73(12), 1172–1182. doi:10.1119/1.2117109
- Confrey, J. (1990). Chapter 8: What Constructivism Implies for Teaching. *Journal for Research in Mathematics Education. Monograph*, 4, 107–210. doi:10.2307/749916
- Costello, A., & Osborne, J. (2005). Best practices in exploratory factor analysis: four recommendations for getting the most from your analysis. *Practical Assessment Research & Evaluation*, 10(7). Retrieved from <http://pareonline.net/getvn.asp?v=10&n=7>
- Crouch, C. (2000, January 18). *Confusion: Students' Perception vs. Reality*. Contributed presented at the American Association of Physics Teachers Winter Meeting, 2000, Kissimmee, FL.
- Crouch, C. H., & Mazur, E. (2001). Peer Instruction: Ten years of experience and results. *American Journal of Physics*, 69(9), 970. doi:10.1119/1.1374249
- Cummings, K., Marx, J., Thornton, R., & Kuhl, D. (1999). Evaluating innovation in studio physics. *American Journal of Physics*, 67(S1), S38–S44. doi:10.1119/1.19078
- Dancy, M. H. (2000). *Investigating animations for assessment with an animated version of the Force Concept Inventory* (Ph.D.). North Carolina State University, Raleigh, NC.
- Deardorff, D. L. (2001). *Introductory physics students' treatment of measurement uncertainty*. North Carolina State University, Raleigh, NC. Retrieved from <http://adsabs.harvard.edu/abs/2001PhDT.....132D>
- Dellwo, D. R. (2010). Course assessment using multi-stage pre/post testing and the components of normalized change. *Journal of the Scholarship of Teaching and Learning*, 10(1), 55–67.
- diSessa, A. A. (2006). A History of Conceptual Change Research: Threads and Fault Lines. *The Cambridge handbook of: The learning sciences*. (pp. 265–281). New York, NY, US: Cambridge University Press.
- Domelen, D. J. V., & Heuvelen, A. V. (2002). The effects of a concept-construction lab course on FCI performance. *American Journal of Physics*, 70(7), 779–780. doi:10.1119/1.1377284

- Dunning, D., Griffin, D. W., Milojkovic, J. D., & Ross, L. (1990). The overconfidence effect in social prediction. *Journal of Personality and Social Psychology*, *58*(4), 568–581.
- Engelbrecht, J., Harding, A., & Potgieter, M. (2005). Undergraduate students' performance and confidence in procedural and conceptual mathematics. *International Journal of Mathematical Education in Science and Technology*, *36*(7), 701–712. doi:10.1080/00207390500271107
- Etkina, E., Karelina, A., & Ruibal-Villasenor, M. (2008). How long does it take? A study of student acquisition of scientific abilities. *Physical Review Special Topics - Physics Education Research*, *4*(2), 020108. doi:10.1103/PhysRevSTPER.4.020108
- Etkina, E., Karelina, A., Ruibal-Villasenor, M., Rosengrant, D., Jordan, R., & Hmelo-Silver, C. E. (2010). Design and Reflection Help Students Develop Scientific Abilities: Learning in Introductory Physics Laboratories. *Journal of the Learning Sciences*, *19*(1), 54–98. doi:10.1080/10508400903452876
- Etkina, E., Van Heuvelen, A., White-Brahmia, S., Brookes, D. T., Gentile, M., Murthy, S., Rosengrant, D., et al. (2006). Scientific abilities and their assessment. *Physical Review Special Topics - Physics Education Research*, *2*(2), 020103. doi:10.1103/PhysRevSTPER.2.020103
- Everson, H. T., & Tobias, S. (1998). The ability to estimate knowledge and performance in college: A metacognitive analysis. *Instructional Science*, *26*(1), 65–79. doi:10.1023/A:1003040130125
- Fencl, H. S., & Scheel, K. R. (2004). Pedagogical approaches, contextual variables, and the development of student self-efficacy in undergraduate physics courses. *AIP Conference Proceedings*, *720*(1), 173–176. doi:doi:10.1063/1.1807282
- Finkelstein, N. D., & Pollock, S. J. (2005). Replicating and understanding successful innovations: Implementing tutorials in introductory physics. *Physical Review Special Topics - Physics Education Research*, *1*(1), 010101.
- Flavell, J. H. (1979). Metacognition and cognitive monitoring: A new area of cognitive–developmental inquiry. *American Psychologist*, *34*(10), 906–911. doi:10.1037/0003-066X.34.10.906
- Galloway, R. K., Bates, S. P., Maynard-Casely, H. E., & Slaughter, K. A. (in press). Data Handling Diagnostic: Design, Validation and Preliminary Findings. *Physical Review Special Topics: Physics Education Research*.
- Garofalo, J., & Lester, F. K. (1985). Metacognition, Cognitive Monitoring, and Mathematical Performance. *Journal for Research in Mathematics Education*, *16*(3), 163. doi:10.2307/748391

- Georghiades, P. (2000). Beyond conceptual change learning in science education: focusing on transfer, durability and metacognition. *Educational Research*, 42(2), 119–139. doi:10.1080/001318800363773
- Gigerenzer, G., Hoffrage, U., & Kleinbölting, H. (1991). Probabilistic mental models: A Brunswikian theory of confidence. *Psychological Review*, 98(4), 506–528. doi:10.1037/0033-295X.98.4.506
- Greeno, J. G. (1997). On Claims That Answer the Wrong Questions. *Educational Researcher*, 26(1), 5–17. doi:10.3102/0013189X026001005
- Gunstone, R. F., & White, R. T. (1981). Understanding of gravity. *Science Education*, 65(3), 291–299. doi:10.1002/sce.3730650308
- Hake, R. R. (1998). Interactive-engagement versus traditional methods: A six-thousand-student survey of mechanics test data for introductory physics courses. *American Journal of Physics*, 66, 64–74.
- Hake, R. R. (2002, August). *Relationship of Individual Student Normalized Learning Gains in Mechanics with Gender, High-School Physics, and Pretest Scores on Mathematics and Spatial Visualization*. submitted to the Physics Education Research Conference, Boise, Idaho.
- Hake, R. R, Wakeland, R., Bhattacharyya, A., & Sirochman, R. (1994). Assessment of individual student performance in an introductory mechanics course. *AAPT Announcer*, 24(4), 76.
- Hake, Richard R. (1992). Socratic pedagogy in the introductory physics laboratory. *The Physics Teacher*, 30(9), 546–552. doi:10.1119/1.2343637
- Halloun, I. A., & Hestenes, D. (1985). The initial knowledge state of college physics students. *American Journal of Physics*, 53(11), 1043–1055. doi:10.1119/1.14030
- Halloun, I., & Hestenes, D. (1996). The search for conceptual coherence in FCI data. *preprint*.
- Hammer, D. (1994). Epistemological Beliefs in Introductory Physics. *Cognition and Instruction*, 12(2), 151–183. doi:10.1207/s1532690xci1202_4
- Hammer, D. (1996). More than misconceptions: Multiple perspectives on student knowledge and reasoning, and an appropriate role for education research. *American Journal of Physics*, 64(10), 1316–1325. doi:10.1119/1.18376
- Hammer, D., & Elby, A. (2003). Tapping Epistemological Resources for Learning Physics. *Journal of the Learning Sciences*, 12(1), 53–90. doi:10.1207/S15327809JLS1201_3
- Hart, J. T. (1965). Memory and the feeling-of-knowing experience. *Journal of Educational Psychology*, 56(4), 208–216. doi:10.1037/h0022263

- Heller, P. (1995). Interpreting the force concept inventory: A reply to Hestenes and Halloun. *The Physics Teacher*, 33(8), 503. doi:10.1119/1.2344279
- Heller, Patricia, & Hollabaugh, M. (1992). Teaching problem solving through cooperative grouping. Part 2: Designing problems and structuring groups. *American Journal of Physics*, 60(7), 637–644. doi:10.1119/1.17118
- Heller, Patricia, Keith, R., & Anderson, S. (1992). Teaching problem solving through cooperative grouping. Part 1: Group versus individual problem solving. *American Journal of Physics*, 60, 627–636.
- Hestenes, D., & Halloun, I. (1995). Interpreting the Force Concept Inventory: A Response to March 1995 Critique by Huffman and Heller. *The Physics Teacher*, 33, 502–506.
- Hestenes, D., Wells, M., & Swackhamer, G. (1992). Force Concept Inventory. *The Physics Teacher*, 30, 141–158.
- Hofstein, A., & Lunetta, V. N. (1982). The Role of the Laboratory in Science Teaching: Neglected Aspects of Research. *Review of Educational Research*, 52(2), 201–217.
- Holton, D., & Clarke, D. (2006). Scaffolding and metacognition. *International Journal of Mathematical Education in Science and Technology*, 37(2), 127–143. doi:10.1080/00207390500285818
- Huffman, D., & Heller, P. (1995). What does the force concept inventory actually measure? *The Physics Teacher*, 33(3), 138–143. doi:10.1119/1.2344171
- Karelina, A. (2011, November 29). personal correspondence.
- Karelina, A., & Etkina, E. (2007). Acting like a physicist: Student approach study to experimental design. *Physical Review Special Topics - Physics Education Research*, 3(2), 020106. doi:10.1103/PhysRevSTPER.3.020106
- Kirschner, P. A., Sweller, J., & Clark, R. E. (2006). Why Minimal Guidance During Instruction Does Not Work: An Analysis of the Failure of Constructivist, Discovery, Problem-Based, Experiential, and Inquiry-Based Teaching. *Educational Psychologist*, 41(2), 75–86. doi:10.1207/s15326985ep4102_1
- Knight, J. K., & Wood, W. B. (2005). Teaching more by lecturing less. *Life Sciences Education*, 4(4), 298.
- Koch, A. (2001). Training in metacognition and comprehension of physics texts. *Science Education*, 85(6), 758–768. doi:10.1002/sce.1037
- Kost, L. E., Pollock, S. J., & Finkelstein, N. D. (2009). Unpacking Gender Differences in Students' Perceived Experiences in Introductory Physics. *Proceedings of the 2009 Physics Education Research Conference*.

- Kruger, J., & Dunning, D. (1999). Unskilled and unaware of it: How difficulties in recognizing one's own incompetence lead to inflated self-assessments. *Journal of Personality and Social Psychology*, 77(6), 1121–1134.
- Kung, R. L. (2005). Teaching the concepts of measurement: An example of a concept-based laboratory course. *American Journal of Physics*, 73(8), 771–777. doi:10.1119/1.1881253
- L. Deslauriers, E. Schelew, and C. Wieman. (2011). Improved Learning in a Large-Enrollment Physics Class. *Science*, 332(6031), 862–864.
- Lasry, N. (2008). Clickers or flashcards: Is there really a difference? *The Physics Teacher*, 46, 242.
- Lasry, Nathaniel, Mazur, E., & Watkins, J. (2008). Peer instruction: From Harvard to the two-year college. *American Journal of Physics*, 76(11), 1066. doi:10.1119/1.2978182
- Lave, J. (1988). *Cognition in Practice: Mind, Mathematics and Culture in Everyday Life*. Cambridge University Press.
- Lent, R. W., Brown, S. D., & Larkin, K. C. (1984). Relation of self-efficacy expectations to academic achievement and persistence. *Journal of Counseling Psychology*, 31(3), 356–362. doi:10.1037/0022-0167.31.3.356
- Lent, R. W., Brown, S. D., & Larkin, K. C. (1987). Comparison of three theoretically derived variables in predicting career and academic behavior: Self-efficacy, interest congruence, and consequence thinking. *Journal of Counseling Psychology*, 34(3), 293–298. doi:10.1037/0022-0167.34.3.293
- Lerman, S. (1996). Intersubjectivity in Mathematics Learning: A Challenge to the Radical Constructivist Paradigm? *Journal for Research in Mathematics Education*, 27(2), 133–150. doi:10.2307/749597
- Li, S. L., & Demaree, D. (2012). Assessing physics learning identity: Survey development and validation. *AIP Conference Proceedings*, 1413(1), 247–250. doi:doi:10.1063/1.3680041
- Linnenbrink, E. A., & Pintrich, P. R. (2003). THE ROLE OF SELF-EFFICACY BELIEFS INSTUDENT ENGAGEMENT AND LEARNING INTHECLASSROOM. *Reading & Writing Quarterly*, 19(2), 119–137. doi:10.1080/10573560308223
- Lippmann Kung, R., & Linder, C. (2007). Metacognitive activity in the physics student laboratory: is increased metacognition necessarily better? *Metacognition and Learning*, 2(1), 41–56. doi:10.1007/s11409-007-9006-9
- Lippmann, R. F. (2003). *Students' understanding of measurement and uncertainty in the physics laboratory: Social construction, underlying concepts, and quantitative analysis*. University of Maryland, College Park, MD, United States.

- Lobato, J. (2003). How Design Experiments Can Inform a Rethinking of Transfer and Vice Versa. *Educational Researcher*, 32(1), 17–20. doi:10.3102/0013189X032001017
- Lobato, J. (2006). Alternative Perspectives on the Transfer of Learning: History, Issues, and Challenges for Future Research. *Journal of the Learning Sciences*, 15(4), 431–449. doi:10.1207/s15327809jls1504_1
- Lorenzo, M., Crouch, C. H., & Mazur, E. (2006). Reducing the gender gap in the physics classroom. *American Journal of Physics*, 74(2), 118. doi:10.1119/1.2162549
- MacIsaac, D., & Falconer, K. (2002). Reforming Physics Instruction Via RTOP. *The Physics Teacher*, 40(8), 479–485.
- Mahajan, S. (2005, December 16). Observations on teaching first-year physics. Retrieved from http://arxiv.org/PS_cache/physics/pdf/0512/0512158v1.pdf
- Maloney, D. P., O’Kuma, T. L., Hieggelke, C. J., & Van Heuvelen, A. (2001). Surveying students’ conceptual knowledge of electricity and magnetism. *American Journal of Physics*, 69(S1), S12. doi:10.1119/1.1371296
- Marx, J. D., & Cummings, K. (2007). Normalized change. *American Journal of Physics*, 75(1), 87–91. doi:10.1119/1.2372468
- Mazur, E. (1997). *Peer instruction: A user’s manual*. Upper Saddle River, New Jersey: Prentice Hall.
- McDermott, L. C., & Shaffer, P. S. (1992). Research as a guide for curriculum development: An example from introductory electricity. Part I: Investigation of student understanding. *American Journal of Physics*, 60(11), 994–1003. doi:10.1119/1.17003
- McDermott, L. C., & Shaffer, P. S. (2001). *Tutorials in Introductory Physics*. Prentice Hall College Div.
- McKagan, S. B., Perkins, K. K., & Wieman, C. E. (2007). Reforming a large lecture modern physics course for engineering majors using a PER-based design. *AIP Conference Proceedings*, 883, 34–37. doi:Article
- McKeachie, W. J. (1987). Cognitive skills and their transfer: Discussion. *International Journal of Educational Research*, 11(6), 707–712. doi:10.1016/0883-0355(87)90010-3
- Meltzer, D. E. (2002). The relationship between mathematics preparation and conceptual learning gains in physics: A possible “hidden variable” in diagnostic pretest scores. *American Journal of Physics*, 70(12), 1259–1268.
- Meltzer, D. E., & Manivannan, K. (2002). Transforming the lecture-hall environment: the fully interactive physics lecture. (Abstract). *American Journal of Physics*, 70, 639(16).
- Merriam-Webster, Inc. (2003). *Merriam-Webster’s Collegiate Dictionary*. Merriam-Webster.

- Moore, D. S., McCabe, G. P., Duckworth, W. M., & Alwan, L. C. (2008). *The Practice of Business Statistics: Using Data for Decisions* (2nd ed.). Palgrave.
- Morris, G. A., Branum-Martin, L., Harshman, N., Baker, S. D., Mazur, E., Dutta, S., Mzoughi, T., et al. (2006). Testing the test: Item response curves and test quality. *American Journal of Physics*, *74*(5), 449–453. doi:10.1119/1.2174053
- Multon, K. D., Brown, S. D., & Lent, R. W. (1991). Relation of self-efficacy beliefs to academic outcomes: A meta-analytic investigation. *Journal of Counseling Psychology*, *38*(1), 30–38. doi:10.1037/0022-0167.38.1.30
- Novak, G. M., Gavrin, A., & Wolfgang, C. (1999). *Just-in-Time Teaching: Blending Active Learning with Web Technology* (1st ed.). Upper Saddle River, NJ, USA: Prentice Hall PTR.
- Perkins, D., & Salomon, G. (1989). Are Cognitive Skills Context-Bound? *Educational Researcher*, *18*(1), 16–25. doi:10.3102/0013189X018001016
- Piaget, J. (1985). *The Equilibration of Cognitive Structures: The Central Problem of Intellectual Development*. Chicago: University of Chicago Press.
- Piaget, J., Green, D. R., Ford, M. P., & Flamer, G. B. (1971). The Theory of Stages in Cognitive Development. In *Measurement and Piaget* (pp. 1–11). New York: McGraw-Hill.
- Piaget, Jean. (1977). *The development of thought: Equilibration of cognitive structures*. (Trans A. Rosin). Oxford, England: Viking.
- Piaget, Jean. (1980). *Adaptation and intelligence : organic selection and phenocopy*. Chicago: University of Chicago Press.
- Pietsch, J., Walker, R., & Chapman, E. (2003). The relationship among self-concept, self-efficacy, and performance in mathematics during secondary school. *Journal of Educational Psychology*, *95*(3), 589–603. doi:10.1037/0022-0663.95.3.589
- Pollock, S. J., Finkelstein, N. D., & Kost, L. E. (2007). Reducing the gender gap in the physics classroom: How sufficient is interactive engagement? *Physical Review Special Topics - Physics Education Research*, *3*(1), 010107.
- Posner, G. J., Strike, K. A., Hewson, P. W., Gertzog, W. A., Posner, G. J., Strike, K. A., Hewson, P. W., et al. (1982). Accommodation of a scientific conception: Toward a theory of conceptual change, Accommodation of a scientific conception: Toward a theory of conceptual change. *Science Education*, *Science Education*, *66*, *66*(2, 2), 211, 211–227, 227. doi:10.1002/sce.3730660207, 10.1002/sce.3730660207
- Redish, E. F. (2004). A Theoretical Framework for Physics Education Research: Modeling Student Thinking. *arXiv:physics/0411149*. Retrieved from <http://arxiv.org/abs/physics/0411149>

- Redish, E. F., Saul, J. M., & Steinberg, R. N. (1997). On the effectiveness of active-engagement microcomputer-based laboratories. *American Journal of Physics*, 65(1), 45–54. doi:10.1119/1.18498
- Redish, E. F., Saul, J. M., & Steinberg, R. N. (1998). Student expectations in introductory physics. *American Journal of Physics*, 66(3), 212–224. doi:10.1119/1.18847
- Reif, F., & John, M. S. (1979). Teaching physicists' thinking skills in the laboratory. *American Journal of Physics*, 47(11), 950–957. doi:10.1119/1.11618
- Reif, F., & Reif, F. (1987). Instructional design, cognition, and technology: Applications to the teaching of scientific concepts, Instructional design, cognition, and technology: Applications to the teaching of scientific concepts. *Journal of Research in Science Teaching, Journal of Research in Science Teaching*, 24, 24(4, 4), 309, 309–324, 324. doi:10.1002/tea.3660240405, 10.1002/tea.3660240405
- Reif, Frederick. (1995). Understanding and Teaching Important Scientific Thought Processes. *Journal of Science Education and Technology*, 4(4), 261–282.
- Resnick, L. B. (Ed.). (1976). *The nature of intelligence*. Oxford, England: Lawrence Erlbaum.
- Rickey, D., & Stacy, A. M. (2000). The Role of Metacognition in Learning Chemistry. *J. Chem. Educ.*, 77(7), 915. doi:10.1021/ed077p915
- Sawtelle, V. (2011). A Gender Study Investigating Physics Self-Efficacy. *FIU Electronic Theses and Dissertations*. Retrieved from <http://digitalcommons.fiu.edu/etd/512>
- Schoenfeld, A. H. (1992). Learning to think mathematically: Problem solving, metacognition, and sense making in mathematics. *Handbook of research on mathematics teaching and learning: A project of the National Council of Teachers of Mathematics*. (pp. 334–370). New York, NY, England: Macmillan Publishing Co, Inc.
- Schraw, G., Crippen, K., & Hartley, K. (2006). Promoting Self-Regulation in Science Education: Metacognition as Part of a Broader Perspective on Learning. *Research in Science Education*, 36(1), 111–139. doi:10.1007/s11165-005-3917-8
- Schwab, Joseph J. (1960). Inquiry, the Science Teacher, and the Educator. *The School Review*, 68(2), 176–195.
- Schwab, Joseph Jackson, & Brandwein, P. F. (1962). *The Teaching of science: The teaching of science as enquiry*. Harvard University Press.
- Seeger, F., & Waschescio, U. (1998). *The Culture of the Mathematics Classroom*. Cambridge University Press.
- Shaughnessy, J. J. (1979). Confidence-judgment accuracy as a predictor of test performance. *Journal of Research in Personality*, 13(4), 505–514. doi:10.1016/0092-6566(79)90012-6

- Shayer, M. (2003). Not just Piaget; not just Vygotsky, and certainly not Vygotsky as alternative to Piaget. *Learning and Instruction*, 13(5), 465–485. doi:10.1016/S0959-4752(03)00092-6
- Singer, S. R., Hilton, M. L., Schweingruber, H. A., & Vision, N. R. C. (U. S.). C. on H. S. S. L. R. and. (2006). *America's Lab Report: Investigations in High School Science*. National Academies Press.
- Sinkavich, F. J. (1995). Performance and metamemory: Do students know what they don't know? *Journal of Instructional Psychology*, 22(1), 77–87.
- Smith, M. K., Wood, W. B., Adams, W. K., Wieman, C., Knight, J. K., Guild, N., & Su, T. T. (2009). Why Peer Discussion Improves Student Performance on In-Class Concept Questions. *Science*, 323(5910), 122–124. doi:10.1126/science.1165919
- Sternheim, M. M., & Kane, J. W. (1991). General Physics, Study Guide, 2nd Edition. *General Physics, Study Guide, 2nd Edition, by Morton M. Sternheim, Joseph W. Kane, pp. 360. ISBN 0-471-53485-4. Wiley-VCH, January 1991*. Retrieved from <http://adsabs.harvard.edu.ezp-prod1.hul.harvard.edu/abs/1991gpsg.book.....S>
- Tuomi-Gröhn, T., & Engeström, Y. (2003). *Between School and Work: New Perspectives on Transfer and Boundary-Crossing*. Emerald Group Publishing.
- Vygotskiĭ, L. S., & Cole, M. (1978). *Mind in Society: The Development of Higher Psychological Processes*. Harvard University Press.
- Wang, J., & Bao, L. (2010). Analyzing force concept inventory with item response theory. *American Journal of Physics*, 78(10), 1064–1070.
- Ward, M., Gruppen, L., & Regehr, G. (2002). Measuring Self-assessment: Current State of the Art. *Advances in Health Sciences Education*, 7(1), 63–80. doi:10.1023/A:1014585522084
- Watkins, J. E. (2010). *Examining Issues of Underrepresented Minority Students in Introductory Physics* (Ph.D.). Harvard University, United States -- Massachusetts.
- Wells, L., Valenzuela, R., Brewster, E., Kramer, L., O'Brien, G., & Zamalloa, E. (2008). Impact of the FIU PhysTEC Reform of Introductory Physics Labs. *AIP Conference Proceedings*, 1064(1), 227–230. doi:doi:10.1063/1.3021261
- Welzel, M., Haller, K., Bandiera, M., Hammelev, D., Koumaras, P., Niedderer, H., Paulsen, A., et al. (1998). *Teachers' Objectives For Labwork: Research Tool And Cross Country Results* (No. Project PL 95-2005). Labwork in Science Education.
- Wiggins, G. P. (2005). *Understanding by Design* (Expanded 2nd ed.). Alexandria, VA: Association for Supervision and Curriculum Development.

Zeldin, A. L., & Pajares, F. (2000). Against the Odds: Self-Efficacy Beliefs of Women in Mathematical, Scientific, and Technological Careers. *American Educational Research Journal*, 37(1), 215–246. doi:10.3102/00028312037001215

Appendix A

Reading Exercise Questions

Instructions (common to all questions)

In answering the following questions, we ask that you please respond to each question in order.

If you find that, after considering questions 2 and 3, you feel differently about question 1, you will have an opportunity to revise your answer in question 4.

Your responses, particularly to questions 1 and 4, provide you with a genuine opportunity to voice your opinion and influence the direction of our discussion in class.

A.1 P11a – Exercise 1

Confusion Topics

Position and displacement, Representing motion, Average speed and velocity, Scalars and vectors, Velocity as a vector, Instantaneous velocity

Content-Related Questions

2. The motion of three cars in a single lane of traffic, labeled as x , as a function of time is displayed in this figure:

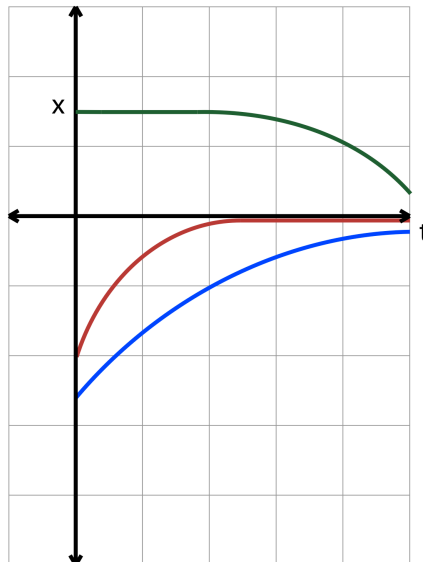

If the cars collide at some later time, which car is most likely to be responsible for the collision?

- (1) **the green car**
- (2) the red car
- (3) the blue car
- (4) all of the cars
- (5) There is no way to determine this.

3. The motion of three cars in a single lane of traffic, labeled as x , as a function of time is displayed in this figure:

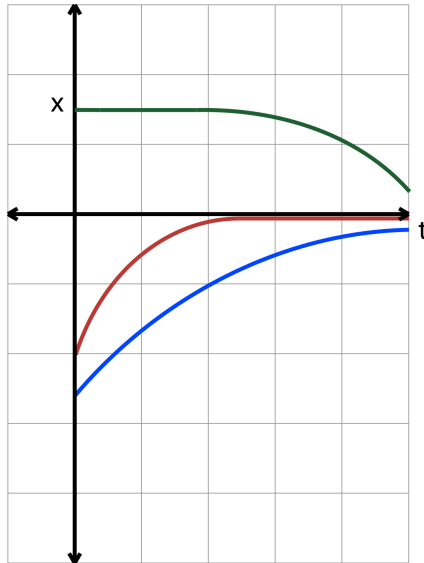

During the time interval displayed, which car reached the largest speed?

- (1) the green car
- (2) **the red car**
- (3) the blue car
- (4) More information is required.

A.2 P11a – Exercise 2

Confusion Topics

Changes in velocity, Acceleration due to gravity, Projectile motion, Motion diagrams, Inclined planes, Instantaneous acceleration

Content-Related Questions

2. A graph of an objects motion is displayed here, where v represents the x-component of velocity:

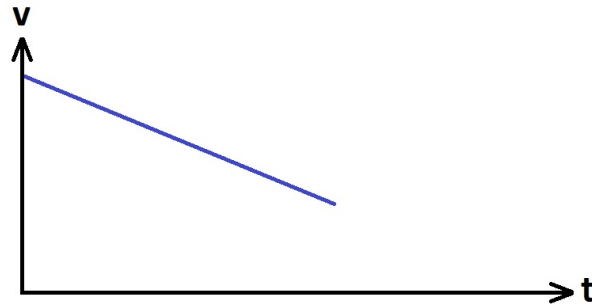

Which sentence is the best interpretation?

- (1) **The object is moving with a constant acceleration.**
 - (2) The object is moving with a uniformly decreasing acceleration.
 - (3) The object is moving with a uniformly increasing velocity.
 - (4) The object is moving at a constant velocity.
 - (5) The object does not move.
3. In this figure, both a graph (a) and a motion diagram (b) are shown.

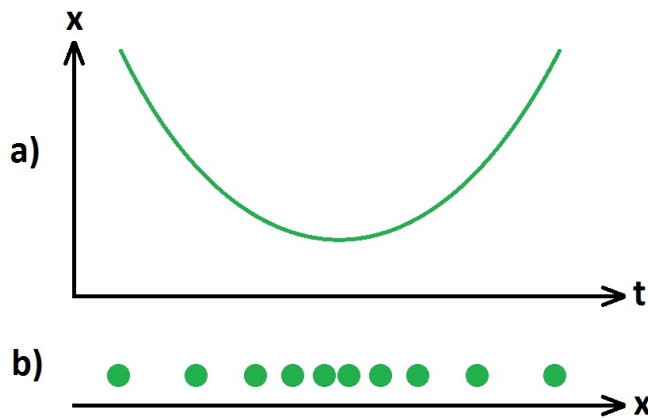

Could both of these representations be displaying the motion of the same object over a

specific time interval?

- (1) yes
- (2) no**
- (3) Impossible to say without more information.

A.3 P11a – Exercise 3

Confusion Topics

Friction, Inertia, Systems, Momentum, Isolated systems, Conservation of momentum

Content-Related Questions

2. You are standing on the surface of the moon, where there is no atmosphere (and, therefore, no air resistance). There is a gravitational attraction between the moon and objects on the surface. If you are holding a heavy moon rock and a feather, and you want to throw one of them as high as possible, which one should you throw?

- (1) the feather**
- (2) the moon rock
- (3) It does not matter; they will both reach the same height.

3. Paintball, if you don't happen to know, is a game in which players on opposing teams fire small paint-filled pellets at one another. If you get hit on your bare arm with a pellet during paintball, which of these scenarios would cause the **least** amount of pain?

- (1) The pellet bounces off of you after striking.
- (2) The pellet breaks against you after striking.**
- (3) Both scenarios would cause equal amounts of pain.
- (4) Either scenario could cause the least amount of pain.

A.4 P11a – Exercise 4

Confusion Topics

Classification of collisions, Kinetic energy, Internal energy, Closed systems, Elastic collisions, Inelastic collisions, Conservation of energy, Explosive separations

Content-Related Questions

2. A metal ball with some initial speed (relative to the stationary table upon which this is all set up) moves toward a magnet. The magnet is set up so that there are two identical metal balls on the other side of the magnet (as pictured). The incoming metal ball is attracted to the magnet (think about refrigerator magnets), so the speed of the ball increases closer to collision (the magnet, too, is pulled toward the ball). After collision, the incoming metal ball sticks and the second of the two additional metal balls flies off (as pictured). The final speed of this ejected metal ball is greater than the initial speed of the incoming metal ball. We can ignore any effects of friction.

before:

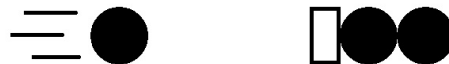

after:

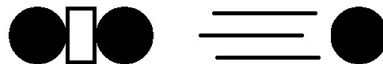

Which of the following statements is true?

- (1) The internal energy of the final system is greater than the internal energy of the initial system.

- (2) **The internal energy of the final system is less than the internal energy of the initial system.**
- (3) The internal energy of the final system is equal to the internal energy of the initial system.
- (4) This situation is not possible; the second ball must be moving at a speed lesser than or equal to the initial speed of the incoming ball.

3. Two identical carts moving on a frictionless track collide. When I measure the relative speeds before and after collision, the values appear to be equal. However, I had placed a small dab of paint on one cart, and during the collision some of the paint transferred to the other cart (so if I played a recording of the collision in reverse, it would be obvious).

Which of the following is true?

- (1) The collision was elastic, but not exactly reversible in this case.
- (2) **The collision was inelastic, but the change in velocities was very small.**
- (3) The collision was elastic, and the paint does not matter (it is superficial).
- (4) The collision was inelastic, but the relative velocities did not happen to change in this case.

A.5 P11a – Exercise 5

Confusion Topics

Relativity of motion, Inertial reference frames, Principle of relativity, Zero-momentum reference frame, Galilean relativity, Center of mass, Convertible kinetic energy, Conservation laws and relativity

Content-Related Questions

2. You throw a ball in the air as hard as you can and note the time at which it stops instantaneously and reverses direction. While you are doing this, a spectator being lifted on a hydraulic platform at a constant speed also notes the time at which the ball stops

instantaneously and reverses direction. Is the time reported by the spectator earlier, later, or the same as the time you report?

- (1) **Spectator notes an earlier time.**
- (2) Spectator notes a later time.
- (3) Spectator notes the same time as you.

3. Is there a reference frame in which the kinetic energy of a system (the whole system – not an individual part of a system) is at a minimum? Is there a frame in which the kinetic energy of a system is at a maximum?

Please note that this question refers to **any** system -- question 3 is not explicitly linked to question 2.

- 1) The kinetic energy can be as low as zero or high as infinity; no limits.
- 2) There is a maximum kinetic energy, but the minimum could always be zero in some frame.
- (3) **There is a minimum, but the maximum could always be infinity in some frame.**
- (4) There are limits to both the minimum and maximum kinetic energy.
- (5) The kinetic energy of the system is constant, regardless of frame.

A.6 P11a – Exercise 6

Confusion Topics

Effects of interactions, Potential energy, Energy dissipation, Source energy, Interaction range, Fundamental interactions, Interactions and acceleration, Nondissipative interactions, Dissipative interactions

Content-Related Questions

2. Which of the following scenarios fit(s) with the energy bars shown here?

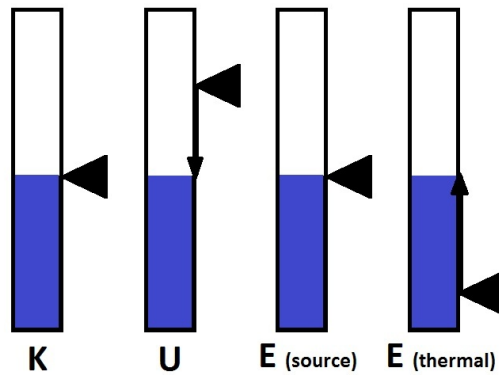

- (1) A person coasting (no brakes) downhill on a bike.
- (2) **A person parachuting from a plane at terminal (constant) speed.**
- (3) A person climbing a ladder at a constant speed.
- (4) A person riding a moving walkway at the airport.
- (5) None of the above.

3. In class, we saw that a fan on a cart that is blowing against a barrier that is also fixed on the same cart generates no motion. We also learned, however, that a person on a platform throwing balls against a barrier that is fixed on the same platform **does** generate motion. Which of the following scenarios, if carried out on the platform with the barrier, would generate motion?

- (1) Sandblasting the barrier.
- (2) Throwing socks filled with nickels at the barrier.
- (3) Spraying the barrier with a fire hose.
- (4) All of the above.
- (5) **None of the above.**

A.7 P11a – Exercise 7

Confusion Topics

Momentum and force, Reciprocity of forces, Identifying forces, Translational equilibrium, Free-

body diagrams, Springs and tension, Equation of motion, Force of gravity, Hooke's Law, Impulse, Two interacting objects, Many interacting objects

Content-Related Questions

2. When I push a crate across the floor *and the crate is accelerating*, which force is greater in magnitude?

- (1) The force I am applying to the crate.
- (2) The force the crate is applying to me.
- (3) Neither is greater; both forces are equal.**
- (4) More information is needed to say for sure.

3. I am hanging from a spring (a fairly heavy-duty spring, so I am definitely in the elastic region), and the spring is attached to the ceiling by a somewhat flimsy hook. In fact, the hook seems to just barely hold up when I am hanging perfectly still on the spring. What will happen when I start to squirm and bounce on the spring? What would happen if it were a rope instead of a spring (assuming the rope and the spring weigh the same, so the hook is barely holding up in just the same way)?

- (1) The hook will break, whether it is a rope or a spring.**
- (2) The hook will break when there's a spring, but hold when there's a rope.
- (3) The hook will break when there's a rope, but hold when there's a spring.
- (4) The hook will hold, whether it is a rope or a spring.
- (5) We need more information.

A.8 P11a – Exercise 8

Confusion Topics

Force displacement, Positive and negative work, Energy diagrams, Choice of system, Work done on a single-particle system, Work done on a many-particle system, Variable and distributed

forces, Power

Content-Related Questions

2. You throw an egg up in the air, and then you catch it. What can you say about the net work that was done on the egg during this process?

- (1) The net work done on the egg was positive.
- (2) The net work done on the egg was negative.
- (3) The net work could have been positive or negative.
- (4) No net work was done on the egg.**
- (5) I cannot say anything without more information.

3. You are pushing a cart up a hill. If you choose to follow the path that switches back and forth across the hill, rather than pushing the cart straight up the slope, what exactly are you minimizing? Assume that you would be travelling at the same pace, regardless of the path that is chosen.

- (1) The work that you do on the cart.
- (2) The work that Earth (gravity) does on the cart.
- (3) The total source energy (from your muscles) that you expend.
- (4) The average power that you expend.**
- (5) The average kinetic energy of you and the cart.

A.9 P11a – Exercise 9

Confusion Topics

Straight is a relative term, Vectors in a plane, Decomposition of forces, Friction, Work and friction, Vector algebra, Projectile motion in two dimensions, Work as the product of two vectors, Coefficients of friction

Content-Related Questions

2. Three swimmers who all swim at the same speed jump into a fast flowing river at the same time. Swimmer A aims straight across but ends up downstream. Swimmer B aims at an upstream angle such that he will reach the other side directly across from where he starts. Swimmer C aims at a downstream angle, along with the current. If they all start right away, which swimmer gets across first?

- (1) **Swimmer A**
- (2) Swimmer B
- (3) Swimmer C
- (4) All three will tie.
- (5) Two of the three will tie.

3. Which of the following balls would you expect to travel the farthest before coming to rest (assume they all start with the same speed, and they all eventually come to rest)?

- (1) a rubber ball rolling on a basketball court
- (2) **a rubber ball rolling on a hockey rink**
- (3) a rubber ball skidding on a hockey rink
- (4) Both of the rolling balls will travel equally farther than the skidding ball.
- (5) All three will come to rest at the same distance.

A.10 P11a – Exercise 10

Confusion Topics

Circular motion at constant speed, Forces and circular motion, Rotational inertia

Content-Related Questions

2. You notice that, as you are copying a CD onto your computer, the rate at which it copies increases as the transfer progresses. You know that the first track of the CD is on the

innermost part of the disc. You also know that the recording mechanism is a laser that moves radially inward/outward as the disc spins. So as the transfer progresses and the laser moves radially outward, what can you say about the rotational velocity of the CD?

- (1) The rotational velocity is increasing.
- (2) The rotational velocity is constant.
- (3) The rotational velocity is decreasing.
- (4) The rotational velocity is constant or increasing, but not decreasing.
- (5) **We cannot say; we need more information.**

3. You swing a heavy ball in a vertical circle motion using a lightweight rope at a constant rotational velocity. Where in the path is the rope the most likely to break?

- (1) At the top of the circle.
- (2) **At the bottom of the circle.**
- (3) Somewhere along the upward path.
- (4) Somewhere along the downward path.
- (5) Position along the path doesn't matter; only rotational velocity matters.

A.11 P11a – Exercise 11

Confusion Topics

Rotational kinematics, Angular momentum, Rotational inertia of extended objects

Content-Related Questions

2. Two hockey sticks are at rest on an ice rink. One is pinned to the ice (a spike through the blade into the ice holds it in place, but the stick can rotate freely), and one is sitting freely on the ice. If a puck slides in and hits the handle of the free stick, is momentum conserved (by "conserved" I mean "approximately conserved" -- we know that ice is not perfectly frictionless, but that's not the effect we're interested in here)? How about angular

momentum? What if the puck hits the pinned stick?

- (1) Both momentum and angular momentum are conserved, regardless of whether the stick is pinned.
 - (2) Only momentum is conserved with the free stick, and only angular momentum is conserved with the pinned stick.
 - (3) **Angular momentum is conserved in both cases, though momentum is conserved with the free stick.**
 - (4) Momentum is conserved in both cases, though angular momentum is conserved with the pinned stick.
 - (5) Neither momentum nor angular momentum is conserved in either case.
3. You are on one of those miniature merry-go-rounds at a park; it doesn't have a motor, but a friend pushes you up to speed by holding on and running around it. The merry-go-round is not very big, and it doesn't weigh much more than you. Once it is up to speed, your friend stops pushing. Your feet are just barely gripping the surface (as in, the force of friction is near its max) when you are standing near the outer edge. As you begin to walk and make your way inward...
- (1) You will remain very close to slipping the entire time, but you won't slip.
 - (2) It will become easier to avoid slipping; the force of friction will no longer be near its max.
 - (3) **You will slip.**
 - (4) More information is needed.

A.12 P11a – Exercise 12

Confusion Topics

Torque and angular momentum, Free rotation, Extended free-body diagrams, The vectorial nature of rotation

Content-Related Questions

2. When you drop a wrench (or anything, really) from some height, you can impart some rotation on that wrench. This means that some parts of the wrench are going to move upward relative to other parts of the wrench. However, is it possible to impart enough rotation so that some parts of the wrench actually move upward as it falls in your "ground" frame of reference?

- (1) No. From the ground, even though it is rotating, all parts of the wrench always move downward.
- (2) **Some parts of the wrench may be moving upward from the ground, but this is not necessarily true.**
- (3) Yes. If the wrench is rotating, some parts of it must be moving upward.

3. You are trying to tighten a nut as much as possible using a wrench (either with or without an extension rod), and you are considering the four configurations pictured below:

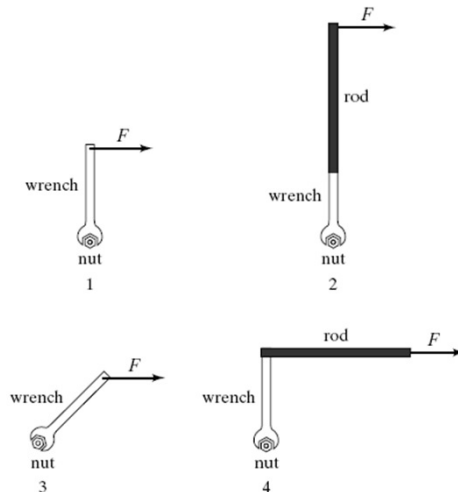

How do these configurations rank, from most successful to least successful, when it comes to tightening the nut?

- (1) All configurations are equally successful.
- (2) 1,2, and 4 are equally better than 3.
- (3) 2 and 4 are equally better than 1 and 3.

- (4) 2 is the best, 4 is less successful, 3 is even worse, and 1 is the worst.
- (5) **2 is the best, 1 and 4 are equally less successful, and 3 is the worst.**

A.13 P11a – Exercise 13

Confusion Topics

Conservation of angular momentum, Rolling motion, Torque and energy, The vector product

Content-Related Questions

2. When you press down on the gas pedal while driving a car, assuming the tires do not slip, is there a friction force acting on the tires as you speed up? Is there a friction force when you are driving at a constant velocity (still pressing the gas, though, to maintain speed)? Is there a friction force when you are coasting (no longer pressing the gas pedal, and therefore gradually slowing down)?
 - (1) No friction force in any case.
 - (2) **No friction force at constant velocity, but yes in other cases.**
 - (3) No friction force while coasting, but yes in other cases.
 - (4) No friction forces at constant velocity or while coasting, but yes when speeding up.
 - (5) Yes, there is a friction force in all cases.

3. What happens when you lean to the right while riding a bicycle?
 - (1) You apply a torque that makes the bike speed up.
 - (2) **You apply a torque that makes the bike turn right.**
 - (3) You apply a torque that makes the bike tip over to the right.
 - (4) You apply a torque that makes the bike tip over to the left.
 - (5) Nothing happens; no torque is applied.

A.14 P11a – Exercise 14

Confusion Topics

Universal gravity, Gravity and angular momentum, Weight, Principle of equivalence, Gravitational constant, Gravitational potential energy, Celestial mechanics, Gravitational force exerted by a sphere

Content-Related Questions

2. When you throw a ball from the roof of a building to the ground below, what is the trajectory that it takes?
 - (1) hyperbola
 - (2) parabola
 - (3) ellipse**
 - (4) It depends on the initial speed.
 - (5) It depends on the initial toss angle.

3. Suppose that there exists a planet just as large as the Earth, but it is hollow and all of its mass is condensed to a thin, uniform spherical shell. If you are on the inside of this planet, where does the gravitational force direct you?
 - (1) It forces me toward the center of the hollow sphere.
 - (2) It forces me toward the nearest surface of the hollow sphere.
 - (3) There is no net gravitational force.**
 - (4) It forces me toward the far side of the hollow sphere.
 - (5) More information is needed.

A.15 P11a – Exercise 15

Confusion Topics

Time measurements, *Simultaneous* is a relative term, Space-time, Matter and energy, Time

dilation, Space contraction

Content-Related Questions

2. Imagine you are driving away from a clock tower in a car that is accelerating and moving really, really fast. As you continue to increase your speed, you observe that the clock is ticking more and more slowly. Consider these two statements:

A) You observe the clock slowing down because the light takes longer to reach you as you drive away.

B) You observe the clock slowing down because the time passes more slowly at the tower as you drive away.

Which of the following is true?

- (1) Statement A is true, but statement B is false.
- (2) Statement A is false, but statement B is true.
- (3) Both statements are different ways of describing the same effect, so both are true.
- (4) **Both statements describe different effects, and both are true.**
- (5) Both statement A and statement B are false.

3. Consider a system of three particles. Two particles are tethered together by a spring, and they are bouncing back and forth with respect to one another (so the spring is compressed and extended periodically). Thus, the internal energy is changing. The third particle is off to one side, away from the particle-spring system. When you consider relativistic effects, is the center of mass of this three-particle system changing with the oscillation?

- (1) Yes, the center of mass is changing periodically.
- (2) **No, the center of mass is not changing.**
- (3) Maybe it changes, but it depends on the position of the third particle.
- (4) Maybe it changes, but it depends on the inertia of each particle in the particle-spring system.
- (5) Maybe it changes, but it depends on the inertia of the third particle.

A.16 P11a – Exercise 16

Confusion Topics

Conservation of momentum, Conservation of energy

Content-Related Questions

2. We know that a particle cannot move at a velocity larger than c , the speed of light in vacuum.

Is there a "maximum momentum" of this particle that an observer can measure? Of course, there could be experimental factors that limit measurement, but here we are focusing on theoretical limits.

- (1) **No, there is no maximum momentum.**
- (2) Yes, there is a maximum momentum.
- (3) There could be a maximum, depending on the speed of the observer.
- (4) There is no maximum momentum, but there is a theoretical limit to what can be measured by an observer.
- (5) There is a maximum momentum, but an observer will not be sensitive to this limit through measurement.

3. You know that hydrogen and oxygen can naturally occur as molecular hydrogen (H_2), molecular oxygen (O_2), and water (H_2O). You are trying to figure out whether it makes more sense for a battery to generate power by turning molecular hydrogen and oxygen into water, or by turning water into molecular hydrogen and oxygen. At the very minimum, what do you need to measure?

- (1) **You must measure the mass of molecular hydrogen, molecular oxygen and water.**
- (2) You must measure the mass of molecular and atomic oxygen.
- (3) You must measure the mass of atomic (not molecular) hydrogen and oxygen.
- (4) You must measure all masses: atomic hydrogen and oxygen, molecular hydrogen and oxygen, and water.

- (5) You don't need to measure any masses to answer this question.

A.17 P11a – Exercise 17

Confusion Topics

Periodic motion and energy, Simple harmonic motion, Fourier's theorem, Restoring forces in simple harmonic motion, Energy of a simple harmonic oscillator, Simple harmonic motion and springs, Restoring torques, Damped oscillations

Content-Related Questions

2. You have a grandfather clock, but it is running a bit slowly because the pendulum takes longer than one second to swing back and forth. You cannot shorten the pendulum (it is hanging from a stiff rod, not a string), but you have an additional mass that you can clamp anywhere along its length. Could adding this mass possibly fix the clock?
- (1) **Yes, clamping the mass to the pendulum could fix the clock.**
 - (2) No, clamping the mass to the pendulum will not affect the clock.
 - (3) No, clamping the mass to the pendulum will further slow the clock.
 - (4) There's no way to know how the mass will affect the clock without more information.
3. You are trying to measure the mass of a block by hanging it from the ceiling on a spring with a known spring constant and measuring the frequency of oscillation. You know, however, that there is going to be some (perhaps small, but still present) effect of air resistance. Does this affect your measurement?
- (1) Yes, this means that I will only be able to set a lower limit on the mass.
 - (2) **Yes, this means that I will only be able to set an upper limit on the mass.**
 - (3) Yes, this affects the measurement, but it is impossible to determine whether the

- measurement is high or low.
- (4) No, this does not affect the measurement.

A.18 P11a – Exercise 18

Confusion Topics

Representing waves graphically, Wave propagation, Superposition of waves, Boundary effects, Wave functions, Standing waves, Wave speed, Energy transport in waves, The wave equation

Content-Related Questions

2. When you pluck a single guitar string so that a single note is produced (in other words, one frequency dominates any higher harmonics), and you can hear this note from across the room, is this an example of how energy is transported down the string?
- (1) Yes, it is.
(2) It can be, depending on the note.
(3) It can be, as long as the higher harmonics are small enough.
(4) **No, it is not.**
(5) It is impossible to determine this.
3. You are looking at a snapshot of a standing wave on a rope, but at this particular instant the rope is totally straight. From the picture, is it possible for you to identify the nodes along this rope? If not, what would you need to know?
- (1) It is possible to identify the nodes.
(2) The total energy of the wave must be known to find the nodes.
(3) The tension and mass density of the rope must be known to find the nodes.
(4) **The energy, tension and mass density all must be known to find the nodes.**
(5) Even with all of this information, it is not possible to find the nodes.

A.19 P11a – Exercise 19

Confusion Topics

Wavefronts, Sound, Interference, Diffraction, Intensity, Beats, Doppler effect, Shock waves

Content-Related Questions

2. In a concert hall, you are worried about “dead spots,” or places where the audience won’t be able to hear all of the sounds from the stage because of destructive interference. Will hanging carpets on the walls (which absorb and dampen sound) help eliminate dead spots?
- (1) No, carpets will only reduce the volume even further.
 - (2) No, carpets won't affect dead spots one way or the other.
 - (3) Some carpets could help, but some carpets could exacerbate the problem.
 - (4) Carpets may help, but they definitely won't make the dead spots worse.**
 - (5) Yes, carpets will definitely help eliminate dead spots.
3. On a particular street, there is a very narrow alley that opens onto a wide street (as shown in the following figure).

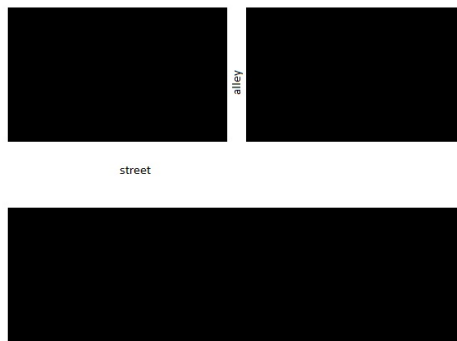

In one situation, you are parked down the street and a squad car (with sirens blaring) is parked in the alley. In another situation, you and the squad car have swapped: the squad car (again, sirens blaring) is parked down the street while you are parked in the alley. In which of these two situations will you hear the sirens most clearly?

- (1) You'll hear the sirens best when you are in the alley.
- (2) You'll hear the sirens best when you are in the street.**
- (3) You'll hear the sirens equally well in both situations.
- (4) You cannot hear the sirens in either situation.
- (5) It's impossible to determine how you will hear the sirens.

A.20 P11a – Exercise 20

Confusion Topics

Forces in a fluid, Buoyancy, Fluid flow, Surface effects, Pressure and gravity, Working with pressure, Bernoulli's law, Viscosity and surface tension

Content-Related Questions

2. You have two different balloons. You inflate both of them as much as you possibly can (until your lungs can't push any more air inside the balloons), and you find that one balloon is clearly much bigger than the other. You then connect the balloons to each end of a straw that you've clamped in the middle. Which way will air flow once you remove the clamp?

- (1) Air will flow from the large balloon to the small one.
- (2) Air will flow from the small balloon to the large one.
- (3) No air flows between the balloons.**
- (4) More information is needed to determine how the air flows.

3. There are two beakers, one filled with water and the other filled with vegetable oil. When you put a particular ball in the water, it just barely floats (as in, only a small fraction of the ball is above the surface of the water). When you put the same ball in the oil, it sinks to the bottom.

What happens when you put the ball in the water, and then you pour the vegetable oil on top?

- (1) The ball will remain floating at the same exact height.

- (2) The ball will float lower, just barely touching the oil-water interface.
- (3) The ball will float higher, still partially within the water.**
- (4) The ball will sink to the bottom of the water.
- (5) This cannot be determined from the given information.

A.21 P11a – Exercise 21

Confusion Topics

States, Equipartition of energy

Content-Related Questions

2. Which is more probable, a macrostate in which one particular particle has all of the energy or a basic state in which each particle has an equal fraction of the energy?
- (1) The macrostate is more probable than the basic state.
 - (2) The basic state is more probable than the macrostate.
 - (3) Both states are equally probable.**
 - (4) It is impossible to determine this with only the given information.
3. There are five particles bouncing around in a box. The total energy of all the particles is 10 units. If you track one particle over a long time, what energy is it going to have most of the time?
- (1) 0 units**
 - (2) 1 unit
 - (3) 2 units
 - (4) 2.5 units
 - (5) 10 units

A.22 P11a – Exercise 22

Confusion Topics

Equipartition of space, Evolution toward the most probable macrostate

Content-Related Questions

2. I have a box that I've arbitrarily divided into four equal quadrants. I put 8 pennies in quadrant, and then I leave the system alone for a really, really long time. When I come back (maybe years later), how many pennies am I most likely to find in that initial quadrant?

- (1) **8 pennies**
- (2) somewhere between 2 and 8 pennies
- (3) 2 pennies
- (4) somewhere between 0 and 2 pennies
- (5) More information is needed.

3. Which of the following processes occur because the system is evolving toward the most probable macrostate? Choose all that apply.

- (1) Water freezing into an ice cube.
- (2) **Water freezing into an ice cube, and the surrounding air that is warming up.**
- (3) A refrigerator cooling the interior air by heating up the exterior air.
- (4) Water falling from one height to a lower height.
- (5) None of the above.

A.23 P11b – Exercise 1

Confusion Topics

Static electricity, Electrical charge, Mobility of charge carriers, Charge polarization, Coulomb's law, Force exerted by distributions of charge carriers

Content-Related Questions

2. Positively charged sphere B is placed between two neutral metal spheres A and C, which are connected by metal wire to a metal base, as shown in the figure below.

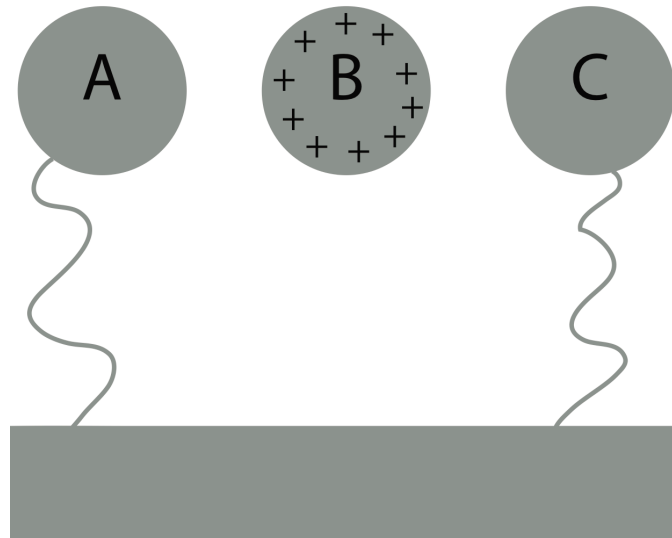

The connections between A and C and the metal base is cut. When sphere A is then brought close to initially-neutral electroscope 1 and sphere C touches the top of initially-neutral electroscope 2, what type of charge does each of the electroscopes carry?

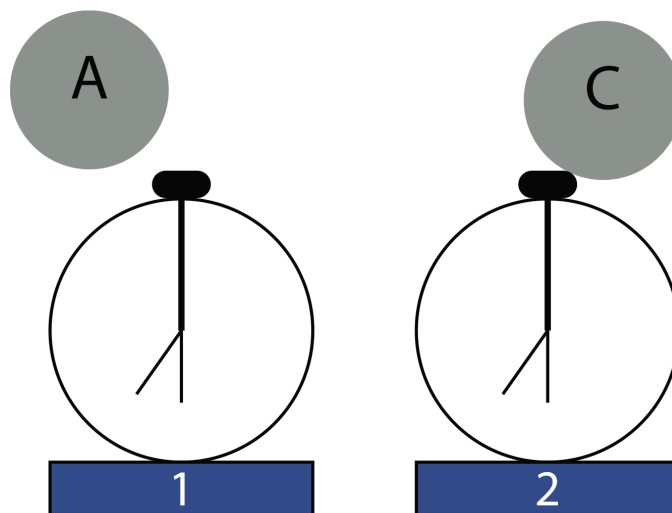

- (1) Electroscope 1 carries a positive charge, and electroscope 2 carries a negative charge.
- (2) **Electroscope 1 is neutral, and electroscope 2 carries a negative charge.**
- (3) Both electroscope 1 and electroscope 2 carry a negative charge.

- (4) Both electroscope 1 and electroscope 2 are neutral.
- (5) We cannot know the charges without more information.

3. Four charged particles, each of the same magnitude, with varying signs are arranged at the corners of a square, as shown. Which of the arrows -- labeled A, B, C, and D -- gives the correct direction of the vector sum of the forces exerted on the particle at the upper-right corner?

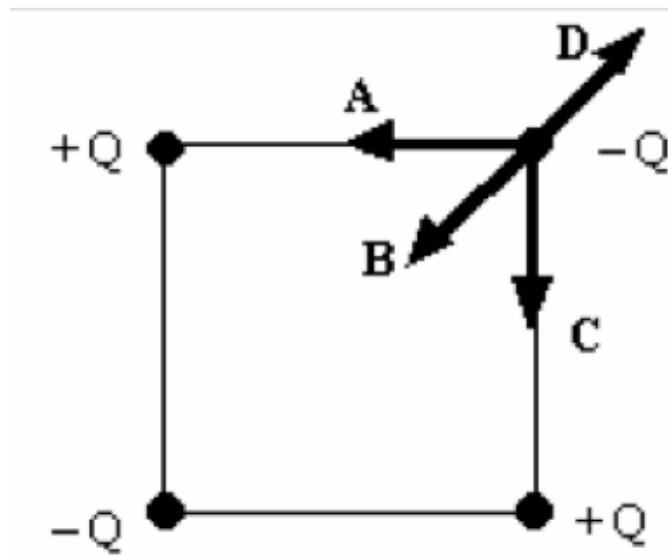

- (1) **A**
- (2) **B**
- (3) **C**
- (4) **D**
- (5) The vector sum of the forces is zero.

A.24 P11b – Exercise 2

Confusion Topics

The field model, Electric field diagrams, Superposition of electric fields, Electric fields and forces, Electric field of a charged particle, Dipole field, Electric fields of continuous charge distributions, Dipoles in electric fields

Content-Related Questions

2. The thin rod of length L depicted below has a charge density, λ , that varies along the rod according to $\lambda = bx^2$, where b is a positive constant.

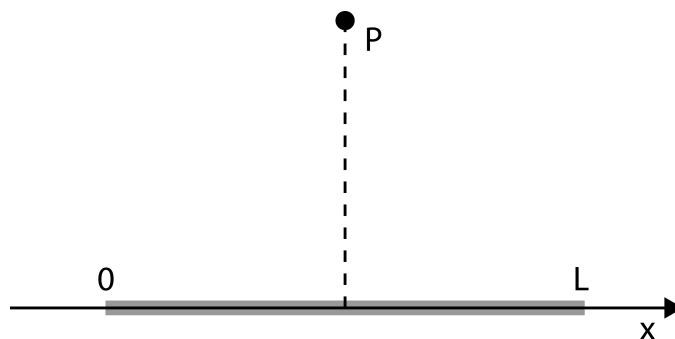

Which of the following diagrams could represent the direction of the electric field at point P ?

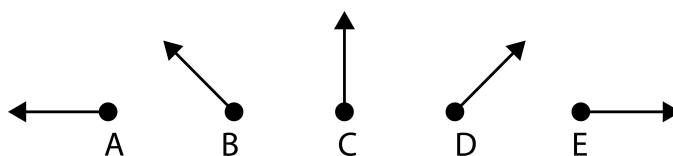

- (1) A
(2) **B**
(3) C
(4) D
(5) E
3. A charged particle is released from rest in a region of uniform electric and gravitational fields. The electric field is directed perpendicular to the gravitational field, and the acceleration of the particle due to the electric field is comparable in magnitude to that due to the gravitational field. Which of the following describes the trajectory of the particle in the combined electric and gravitational fields?
- (1) straight trajectory, constant velocity
(2) parabolic trajectory, constant along electric field and accelerating along gravitational field

- (3) parabolic trajectory, accelerating along electric field and constant along gravitational field
- (4) **straight trajectory, accelerating**
- (5) none of the above

A.25 P11b – Exercise 3

Confusion Topics

Electric field lines, Field line density, Closed surfaces, Symmetry and Gaussian surfaces, Charged conducting objects

Content-Related Questions

2. Consider a field line pattern like the one shown in Figure 24.2 (reproduced below).

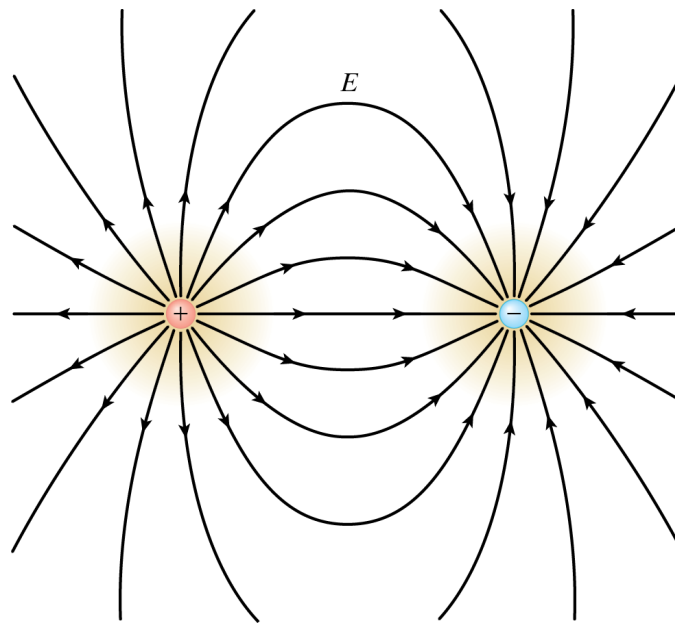

Suppose a negatively charged particle is released from rest from a point on one of the field lines near the top of the diagram. After release, the particle moves...

- (1) along the same direction as the field line.
- (2) along the field line, but in the opposite direction.
- (3) straight toward the negatively charged particle.

- (4) straight toward the positively charged particle.
 - (5) **along some other trajectory.**
3. Consider four charged particles, q_1 , q_2 , q_3 , and q_4 ; q_1 and q_2 lie inside a closed surface; q_3 and q_4 are outside. Which particles contribute to the net flux through the closed surface?
- Which particles contribute to the electric field at the surface of the closed surface?
- (1) All particles contribute to the net flux and the electric field at the surface.
 - (2) All particles contribute to the net flux; q_1 and q_2 contribute to the electric field at the surface.
 - (3) All particles contribute to the net flux; q_3 and q_4 contribute to the electric field at the surface.
 - (4) q_1 and q_2 contribute to the net flux; q_3 and q_4 contribute to the electric field at the surface.
 - (5) **q_1 and q_2 contribute to the net flux; all particles contribute to the electric field at the surface.**

A.26 P11b – Exercise 4

Confusion Topics

Electric flux, Gauss's law, Applying Gauss's law

Content-Related Questions

2. If the same amount of positive charge is distributed uniformly over two large sheets, one conducting and one non-conducting, are the electric fields near the surface of each the same or different?
- (1) **The fields are the same.**
 - (2) The field near the conducting sheet is twice as large as the field near the non-conducting sheet.
 - (3) The field near the non-conducting sheet is twice as large as the field near the conducting sheet.
 - (4) More information is needed.

3. A negatively charged particle is released some distance from:

- 1) a positively charged sphere,
- 2) a long positively charged rod, and
- 3) a large positively charged sheet.

In which of these three cases is the resulting motion of the particle one of constant acceleration?

- (1) Case 1.
- (2) Case 2.
- (3) Case 3.**
- (4) All of the cases.
- (5) None of the cases.

A.27 P11b – Exercise 5

Confusion Topics

Electric potential energy, Electrostatic work, Equipotentials

Content-Related Questions

2. You want to build a new energy storage device to replace batteries. You have a special machine that moves negatively charged particles from one stationary plate to a second plate that is a few centimeters away. Which of the following statements is/are true?

- (1) The more charged particles you move, the more energy is stored.
- (2) The farther the distance between the plates, the more energy is stored.
- (3) With each additional charged particle you move, you store even more energy than you stored with the previous particle you moved.
- (4) Two of the above.
- (5) All of the above.**

3. Your friend has mapped out the equipotential surfaces inside an empty box surrounded by electronic devices. He claims that all the internal equipotential surfaces, which he measured at regular intervals (1 V, 2 V, etc.), are flat parallel planes, but their separation is not constant (in other words, when a test charge is moved from one end of the box to the other, its potential energy increases more near one side compared to the other).

You know that the electronic devices around the box are creating the static electric field inside the empty box, but you do not know the distribution of the field (as in, the distribution of field lines). After thinking about the field lines required to achieve flat equipotential surfaces, you realize that...

- (1) ... **your friend cannot be correct.**
- (2) ... your friend must be correct.
- (3) ... there is no way to tell if you friend is correct without more experimentation.

A.28 P11b – Exercise 6

Confusion Topics

Calculating work and energy in electrostatics, Potential difference, Electrostatic potentials of continuous charge distributions, Obtaining the electric field from the potential

Content-Related Questions

2. You determine the electrostatic potential at a point a certain distance away from a charge distribution. Armed with this information, you can determine:
- (1) the acceleration of an unknown charged particle at that point in space.
 - (2) the magnitude of the electric field at that point in space.
 - (3) the direction of the electric field at that point in space.
 - (4) all of the above
 - (5) **none of the above**

3. You need to calculate the electric field from a continuous charge distribution. Your friend Amed says that it is easiest to determine the electric potential in all space and then calculate the electric field from that. Your second friend, Beth, says that the easiest approach is to use Gauss' Law directly to find the electric field. Finally your third friend, Claryssa, says that Coulomb's Law is the most viable way. What do you think?

- (1) Amed is correct.
- (2) Beth is correct.
- (3) Claryssa is correct.
- (4) Amed or Beth could be correct, but Claryssa is definitely wrong.
- (5) **Any of them could be correct, depending on the charge distribution.**

A.29 P11b – Exercise 7

Confusion Topics

Charge separation, Capacitors, Dielectrics, Voltaic cells and batteries

Content-Related Questions

2. Imagine bringing a positively charged rod near a metal sphere. The rod induces a polarization in the sphere. As the rod is brought near, the electric potential energy of the system comprised of the rod and the sphere...

- (1) increases.
- (2) **decreases.**
- (3) stays the same.
- (4) The answer cannot be determined without more information.

3. A piece of dielectric material is held near a charged rod. How does the magnitude of the electric field inside the dielectric compare to the magnitude of the electric field at the same

location in the absence of the dielectric?

- (1) The magnitude of the electric field is the same in both situations.
- (2) The magnitude of the electric field is greater when the dielectric is present.
- (3) The magnitude of the electric field is greater when the dielectric is not present.**
- (4) There is no electric field inside the dielectric.
- (5) The answer cannot be determined without more information.

A.30 P11b – Exercise 8

Confusion Topics

Capacitance, Electric field energy and emf, Dielectric constant, Gauss' law in dielectrics

Content-Related Questions

2. Consider the insertion of a dielectric material between the plates of a fully charged parallel-plate capacitor that is connected to a battery. What happens to the:

- capacitance (C),
- stored charge (Q),
- electric field between the plates (E) and
- potential difference in the capacitor (V)?

- (1) C increases; Q, E and V remain constant.
- (2) C and Q increase; E and V decrease.
- (3) C and Q increase; E and V remain constant.**
- (4) C, Q and E increase; V remains constant.
- (5) C and V remain constant; Q and E increase.

3. If you decrease the plate distance after a capacitor has been charged and disconnected from a battery, which of the following quantities does not change?

- (i) the potential change from one plate to the other;

- (ii) the electric field line density between the plates;
- (iii) the charge on each plate.

- (1) I does not change.
- (2) II does not change.
- (3) III does not change.
- (4) II and III do not change.**
- (5) None of them change.

A.31 P11b – Exercise 9

Confusion Topics

Magnetism, Magnetic fields, Charge flow and magnetism, Magnetism and relativity, Current and magnetism, Magnetic flux, Moving particles in electric and magnetic fields, Magnetism and electricity unified

Content-Related Questions

2. Two silver bars of the same size and shape are shown below. One is a bar magnet and the other is a metal bar.

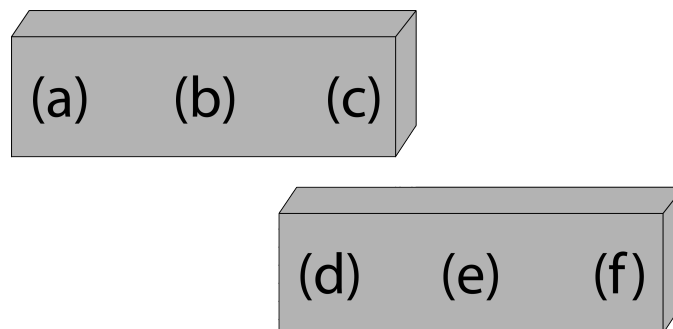

How can you identify which is the magnet?

- (1) Touch (a) to (d).
- (2) Touch (a) to (e).**
- (3) Touch (a) to (d), and then touch (c) to (d).
- (4) Simultaneously touch (a) to (d), (b) to (e), and (c) to (f), bringing them into full

- contact.
- (5) With the two given objects, it's not possible to identify which is magnetic.
3. A positively-charged particle is at rest with respect to a nearby bar magnet. Depending on your reference frame, though, both could be moving with respect to you. Which of the following statements could be correct?
- I. You measure a magnetic force on the particle that is directed along the magnetic field line at the position of the particle.
- II. You measure a magnetic force on the particle that is perpendicular to the magnetic field line at the position of the particle.
- III. You measure no magnetic force on the particle.
- (1) Only I can be correct.
- (2) Only II can be correct.
- (3) Only III can be correct.
- (4) Perhaps I or III could be correct.
- (5) Perhaps II or III could be correct.**

A.32 P11b – Exercise 10

Confusion Topics

Source of the magnetic field, Current loops and spin magnetism, Magnetic moment and torque, Amperian paths

Content-Related Questions

2. A square loop of wire with sides of length L carries a current I in a clock-wise direction; the loop is in a uniform magnetic field B that is pointing to the right, as shown.

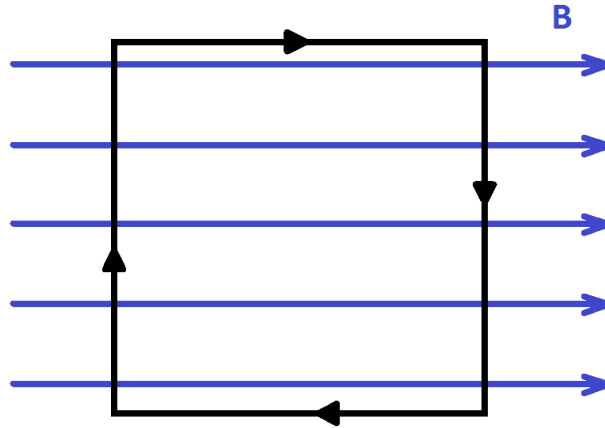

What is the direction of the torque acting on the entire loop?

- (1) The torque is directed up.
- (2) **The torque is directed down.**
- (3) The torque is directed out of the page.
- (4) The torque is directed into the page.
- (5) The torque is directed in some other direction.

3. Consider two possible Amperian paths around a wire. The first path circles around the wire in a plane that is perpendicular to the wire. The second path is almost in the same plane as the wire, but just barely passes on one side of the wire at one point and on the other side of the wire at the opposite point. So both paths enclose the wire, but through very different orientations. Which of the following statements are true?

- (1) The line integrals of the magnetic field along both paths carry the same sign, but the values may be different.
- (2) The line integrals of the magnetic field along each of the paths may carry opposite signs and different values.
- (3) The line integrals of the magnetic field along both paths will yield the same values and carry the same signs.
- (4) **The line integrals of the magnetic field along both paths will yield the same values, but may carry opposite signs.**
- (5) None of these statements are true.

A.33 P11b – Exercise 11

Confusion Topics

Ampere's law, Solenoids and toroids, Magnetic fields due to currents, Magnetic field of a moving charged particle

Content-Related Questions

2. The cable in the diagram below carries currents of equal magnitude, but opposite directions.

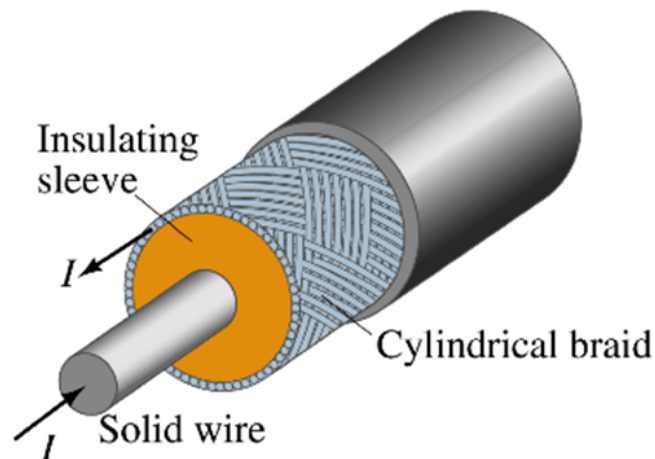

The magnitude of the magnetic field between the two conducting surfaces (within the insulating sleeve) can be expressed as:

$$B = x \left(\frac{\mu_o I}{\pi r} \right).$$

What is x ?

- (1) The value of x is zero; there is no magnetic field.
- (2) **The value of x is 0.5.**
- (3) The value of x is 1.
- (4) The value of x is 2.
- (5) The value of x is not listed above.

3. Compare a path around a single, straight wire to a path around a wire that has been coiled into a solenoid in the region of the loop (as shown below).

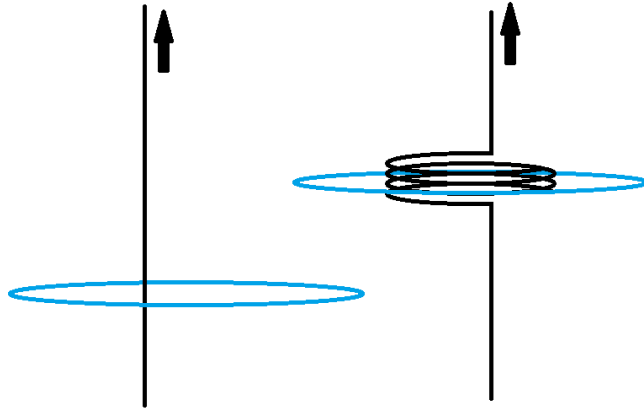

Assuming the current through each wire is the same, how do the line integrals around the paths compare?

- (1) **The line integral around the straight wire is greater.**
- (2) The line integral around the coiled wire is greater.
- (3) The line integrals around both wires are the same.
- (4) There is not enough information to make this comparison.

A.34 P11b – Exercise 12

Confusion Topics

Moving conductors in magnetic fields, Faraday's law, Electric fields accompany changing magnetic fields, Lenz's law

Content-Related Questions

2. A neutrally-charged metal disk in a uniform magnetic field rotates about an axis that passes through its center (as shown).

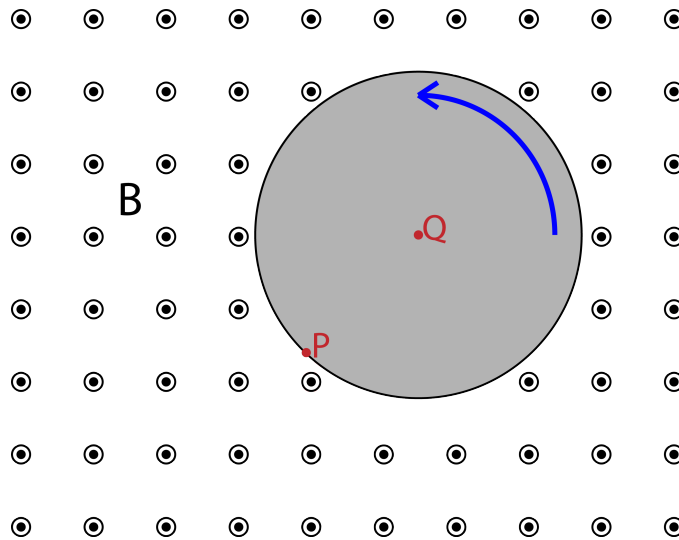

The potential difference of the border with respect to the center of the disk ($V_P - V_Q$) is...

- (1) ... **greater than zero.**
- (2) ... less than zero.
- (3) ... equal to zero.
- (4) ... cannot be determined with the given information.

3. Imagine a large conducting loop around a very long solenoid. As you increase the current through the solenoid, the magnetic field within the solenoid gets larger and larger. However, the magnetic field outside of the solenoid, in the region of the conducting loop, remains essentially zero the entire time. Is a current induced in the loop?

- (1) Yes, current flows through the loop in the same direction as it flows through the solenoid.
- (2) **Yes, current flows through the loop in the opposite direction as it flows through the solenoid.**
- (3) No, there is no current in the loop.
- (4) This cannot be determined.

A.35 P11b – Exercise 13

Confusion Topics

Induced emf, Electric field accompanying a changing magnetic field, Inductance, Magnetic

energy

Content-Related Questions

2. A circular region in which there is a uniform magnetic field and a positively-charged particle P, located out of the field, are displayed in the figure shown here.

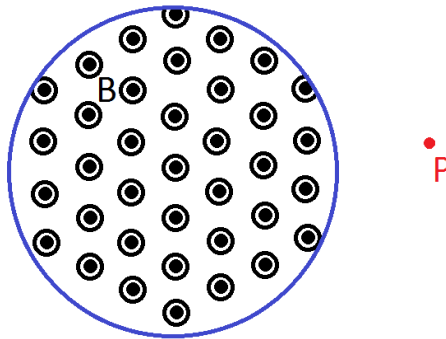

As the magnitude of the magnetic field decreases, there is...

- (1) ... a magnetic force on P.
 - (2) ... **an electric force on P.**
 - (3) ... both a magnetic and an electric force on P.
 - (4) ... no force on P.
 - (5) ... not enough information to determine anything about P.
3. Figure 29.33 shows two paths of integration enclosing the same area A: one circular, the other square. Suppose these paths were replaced by a circular and a square loop of the same shape as these two paths. If the magnetic field, B, increases at a steady rate, in which of the two loops is the induced emf largest?
- (1) The induced emf is largest in the square loop.
 - (2) The induced emf is largest in the circular loop.
 - (3) **The induced emf is non-zero and the same in both loops.**
 - (4) The induced emf is zero in both loops.
 - (5) This cannot be determined with the given information.

A.36 P11b – Exercise 14

Confusion Topics

Magnetic fields accompany changing electric fields, Fields of moving charged particles, Oscillating dipoles and antennas

Content-Related Questions

2. The induced electric field around a changing magnetic field resists the change in magnetic flux. How does the induced magnetic field around a changing electric field affect the change in electric flux?
 - (1) **The induced magnetic field around a changing electric field resists the change in electric flux.**
 - (2) The induced magnetic field around a changing electric field amplifies the change in electric flux.
 - (3) The induced magnetic field around a changing electric field does not affect the change in electric flux.
 - (4) This cannot be determined without more information.

3. Consider a charged particle that is moving parallel to a narrow, conductive rod. Which of the following statements is true?
 - (1) The electric field from a particle moving at a constant velocity can induce a current in a neighboring rod.
 - (2) **The electric field from an accelerating particle can induce a current in a neighboring rod.**
 - (3) The electric field from either a particle moving at a constant velocity or an accelerating particle can induce a current in a neighboring rod.
 - (4) None of the statements are true.
 - (5) It is impossible to determine whether these statements are true.

A.37 P11b – Exercise 15

Confusion Topics

Displacement current, Maxwell's equations, Electromagnetic waves, Electromagnetic energy

Content-Related Questions

2. Suppose a dielectric is inserted between the plates of a capacitor. While the capacitor is charging, is charge being displaced in the space between the plates? If so, is the current due to this displacement in the same direction as the displacement current?
 - (1) No charge is actually displaced.
 - (2) Charge is displaced, but it does not result in a current.
 - (3) **Charge is displaced and the current is in the same direction as the displacement current.**
 - (4) Charge is displaced and the current is in the opposite direction as the displacement current.
 - (5) There is not enough information to determine this.

3. A charged particle is initially at rest in the path of a planar electromagnetic wave pulse (like that shown in figure 30.35). When the wave first interacts with the particle, in which direction does the resulting force on the particle point?
 - (1) The force points in the direction of the Poynting vector.
 - (2) The force points in the direction of the magnetic field.
 - (3) **The force points in the direction of the electric field.**
 - (4) There is no force on the particle.
 - (5) There is not enough information to determine the direction of the force.

A.38 P11b – Exercise 16

Confusion Topics

The basic circuit, Current and resistance, Junctions and multiple loops, Electric fields in

conductors

Content-Related Questions

2. Please refer to Figure 31.16 and assume that both batteries have an emf of 9 V. Suppose you add an additional wire to connect the right terminal of bulb A to the right terminal of bulb B. Immediately after doing this, how do the two bulbs compare to one another (assuming the bulbs are the same)?

- (1) Bulb A is brighter than bulb B.
- (2) Bulb B is brighter than bulb A.
- (3) Both bulbs are equally bright.**
- (4) Bulb B stops emitting light.
- (5) Bulb A stops emitting light.

3. Consider a circuit that includes only a battery and a wire, as shown.

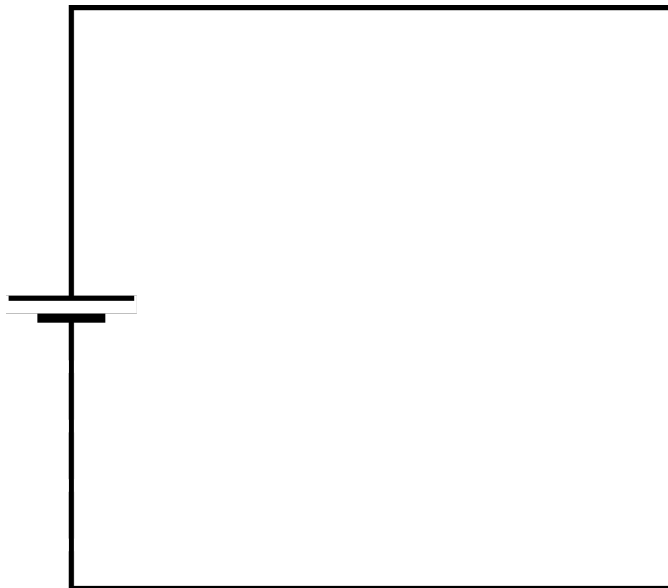

Assuming that the emf of the battery is constant, what happens to the magnitude of the electric field within the wire when you increase the diameter of the wire?

- (1) The magnitude of the electric field decreases.
- (2) The magnitude of the electric field increases.

- (3) **The magnitude of the electric field remains the same.**
- (4) There is no electric field within the wire.
- (5) This cannot be determined with the given information.

A.39 P11b – Exercise 17

Confusion Topics

Resistance and Ohm's law, Single-loop circuits, Multi-loop circuits, Power in electric circuits

Content-Related Questions

2. Which of the following statements holds true *inside* a conductive material, when there is a constant potential difference across the material?
- I. An electric field accelerates electrons to faster and faster velocities.
 - II. Electrons move at a constant average velocity.
 - III. There are no charges inside a conductive material; charges can only exist on the surfaces.
- (1) Only statement I is true.
 - (2) Only statement II is true.
 - (3) Only statement III is true.
 - (4) **Both statements I and II are true.**
 - (5) All three statements are true.
3. You have two identical light bulbs, two identical batteries, and some wire. Which of the following configurations should you choose to maximize the power that is emitted from the bulbs?

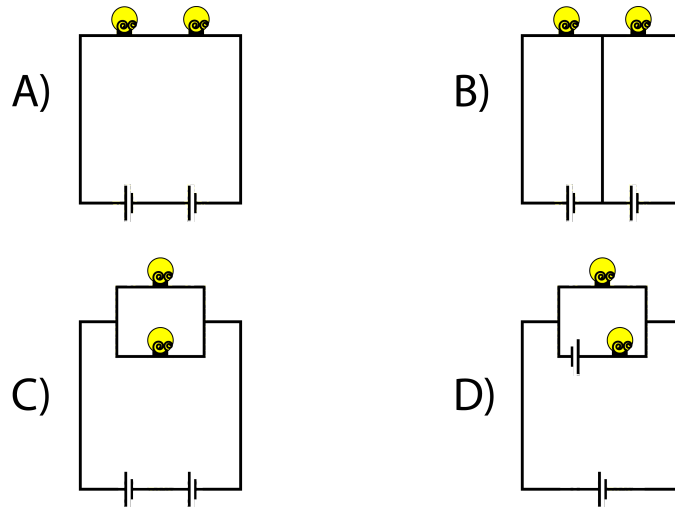

- (1) Configuration A
- (2) Configuration B
- (3) Configuration C**
- (4) Configuration D
- (5) More information is needed.

A.40 P11b – Exercise 18

Confusion Topics

Alternating currents, AC circuits, Semiconductors, Diodes; transistors and logic gates

Content-Related Questions

2. Suppose light gets absorbed in the depletion zone in Figure 32.27c (included here), causing the separation of a hole and an electron.

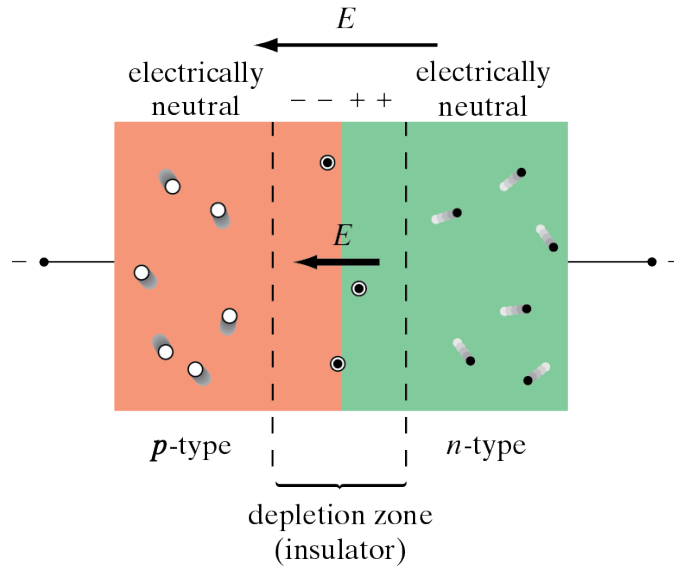

What do you expect will happen as a result of this absorption?

- (1) The electron and hole eventually recombine in the depletion zone.
- (2) The electron and hole remain in the depletion zone, but they do not recombine.
- (3) The electron and hole leave the depletion zone; the electron remains with the other electrons, the hole remains with the other holes.
- (4) The electron and hole leave the depletion zone; once out, they eventually combine with another hole and electron, respectively.
- (5) **The electron and hole leave the depletion zone and generate a current.**

3. Consider a sinusoidally varying current through an inductor. The current generates a magnetic field in the inductor, and the changing magnetic field induces an emf. How does the phase of the induced emf compare to that of the current?

- (1) **The phase of the induced emf lags behind the current.**
- (2) The phase of the induced emf is equal to the phase of the current.
- (3) The phase of the induced emf leads the current.
- (4) The phase of the induced emf is opposite to the phase of the current.
- (5) This cannot be determined without more information.

A.41 P11b – Exercise 19

Confusion Topics

Reactance, RC and RLC circuits, Resonance, Power in AC circuits

Content-Related Questions

2. Consider the high-pass filter shown below.

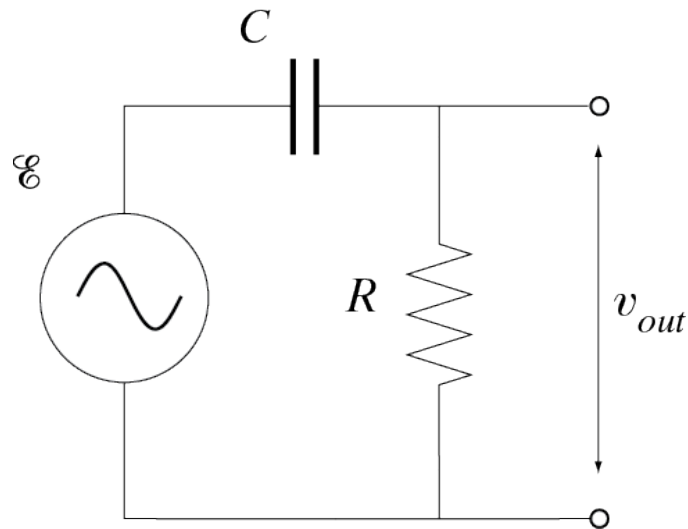

If you were to measure the output potential difference across the capacitor rather than across the resistor, what kind of "filter" would you get?

- (1) You would still have a high-pass filter.
 - (2) **You would have a low-pass filter.**
 - (3) You would have a band-pass filter (a range of frequencies can generate an output potential difference, but not the highest or lowest frequencies).
 - (4) All frequencies would generate an output potential difference; you would have no filter.
 - (5) No frequencies would generate an output potential difference; you would have no signal.
3. Consider an RLC circuit. In each cycle, energy is stored in the capacitor, in the inductor, retrieved from both, and dissipated in the resistor. Which of the following occur

simultaneously, if we apply a sinusoidal source of emf to the circuit?

- A. maximum energy stored in capacitor
- B. maximum energy stored in the inductor
- C. maximum energy dissipated in the resistor

- (1) A and B
- (2) A and C
- (3) B and C**
- (4) A, B and C
- (5) None of them happen simultaneously.

A.42 P11b – Exercise 20

Confusion Topics

Rays, Absorption; transmission and reflection, Refraction and dispersion, Forming images

Content-Related Questions

2. You are standing on the bank of a pond, looking at a fish that is swimming a few feet away from you. Compared to the actual depth at which the fish swims, is the depth at which the fish appears to swim greater, smaller, or the same?

- (1) The apparent depth is greater than the actual depth.
- (2) The apparent depth is smaller than the actual depth.**
- (3) The apparent depth is the same as the actual depth.
- (4) This cannot be determined; more information is needed.

3. Do you need to know anything else about the following lens to determine if it is a converging or diverging lens? Check all that apply.

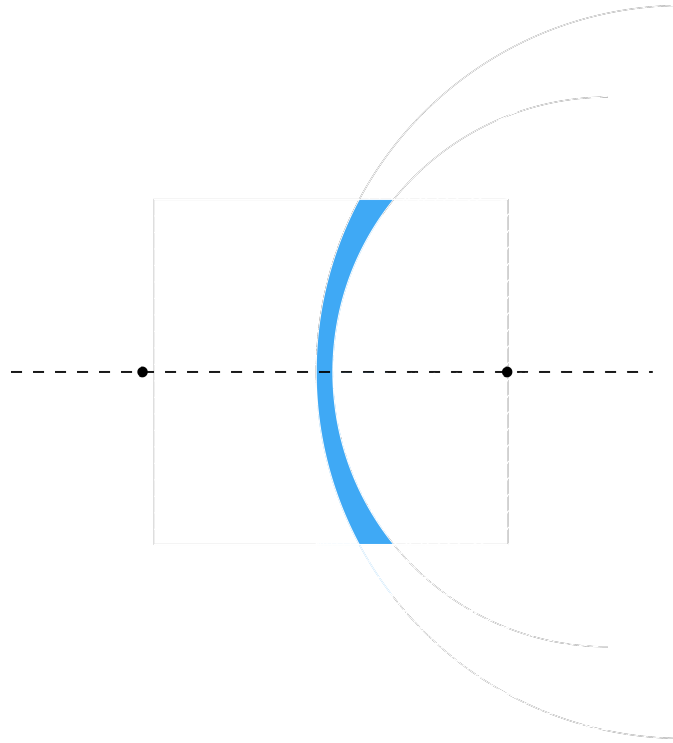

- (1) No, it is a converging lens.
- (2) No, it is a diverging lens.
- (3) We need to know the focal distance.
- (4) We need to know where the source has been placed.
- (5) **We need to know the thickness at the center and edges.**

A.43 P11b – Exercise 21

Confusion Topics

Snell's law, Thin lenses and optical instruments, Spherical mirrors, Lensmaker's formula

Content-Related Questions

2. You are given a converging lens, a diverging lens, a converging mirror, and a diverging mirror. Neglecting combinations, using which of those four can you project an image of a pencil on a screen? Choose all that apply.

- (1) **a converging lens**

- (2) a diverging lens
- (3) a converging mirror**
- (4) a diverging mirror
- (5) None of them.

3. In a combination of two lenses, would it be possible to use the second lens to make a real image of a virtual image formed by the first lens?

- (1) No, it is not possible.
- (2) Yes, it is possible.**

Appendix B

Laboratory Activities

Statement about Organization (common to all laboratory activities)

One lab report should be submitted for each group (please, remember to include all names!). Lab reports should be roughly organized as follows: statement of purpose (or statement of research questions), hypotheses and predictions, experimental procedure, collected data, analysis of collected data and conclusions.

Lab reports will be evaluated using rubrics that were carefully designed to assess scientific abilities. The rubrics that will be used to evaluate this lab report are included at the end of this document. Students are strongly encouraged to thoroughly read through these rubrics before beginning lab reports.

Labs are designed to fill the entire three-hour session. It is important that you work hard and complete as much as you can, but there is no penalty for failing to reach the “finish line.” Please work carefully and thoroughly, and be sure to leave time at the end of the session to prepare what you have completed for submission.

B.1 Laboratory 1 – Electric Fields, Potential Differences and Electrocardiography

(developed from materials prepared by Catherine Crouch, Swarthmore College)

Scientific Ability Rubrics

A1, A2, A3, A4, A7, B1, B5, B6, B7, B8, B9, B10, G1, G2, G3, G4, and G5

Goals

After successfully completing this lab, you will be able to:

- 1) measure the electric potential of various charge distributions over an extended area, creating a map of the potential in space
- 2) derive the electric field from the potential map
- 3) observe the electric fields generated by the human heart by measuring an electrocardiogram

Introduction

This laboratory is divided into two parts. In the first part, you will extend your familiarity with electric fields by exploring their connection to differences in electric potential. In the second

part, you will measure your electrocardiogram (ECG, or EKG [from the German *elektrokardiogramm*]), which is ultimately a more sophisticated measurement of the electric fields generated as your heart contracts and expands.

Part One

Even though we have not yet formally discussed the notion of electric potential energy, we can begin to think about it in the same way we think of gravitational potential energy. As an object with mass falls toward the Earth, gravitational potential energy decreases and kinetic energy increases. Electric potential energy is the potential energy associated with the relative positions of charged objects; as a charged particle moves through an electric field, electric potential energy decreases and kinetic energy increases.

Mathematically, the electric field is associated with a vector function; for a given set of coordinates, the magnitude and direction of this function gives the force per unit charge experienced by a charged particle. The electric potential, on the other hand, is associated with a scalar function; for a given set of coordinates, this function gives the work per unit charge required to move a charged particle through the electric field from an arbitrary reference position to the given coordinates. Thus, the concepts (and associated functions) are deeply related, but quite different from one another.

To illustrate this connection (and reinforce the link between gravitational forces and electrostatic forces), take a moment to look at the terrain maps at your table. As you remember from P11a, gravitational potential energy changes with height: at higher elevations, the gravitational potential energy is greater. So if you were to draw equipotential lines (that is, lines along which the gravitational potential energy does not change), where would you draw them? If

you were to draw gravitational field lines, which represent the direction of the gravitational force on a particle (or, more specifically, the *net* gravitational force; that is, the part that remains when the restoring force of the Earth is taken into account), where would you draw them? What do you notice about these equipotential and field lines?

Contours of constant height on a topographic map are analogous to contours of constant electrostatic potential. In this lab, you will measure the equipotential contours around two or three charge configurations, and then determine the electric field lines from the equipotential map. The electric field and its corresponding potential are produced by distributions of charge. Keep in mind that the (often hypothetical) particle used to measure the strength of the electric field or potential does not contribute to the field.

The charge configurations of which you will measure the fields are shown in Figure 1. In the laboratory, the most straightforward way to produce a distribution of charge is to use a battery or a power supply to produce a potential difference between conducting electrodes. In the configurations we will study, one electrode carries positive charges and the other carries negative charges; charge is conserved in the entire system (power supply, electrodes, and ground) so the net charge of the two electrodes together is zero. You will measure the potential of points around the electrodes using a digital multimeter.

Part Two

A leading interventional cardiologist says that the electrocardiogram is the “among the most valuable clinical tests available to medicine because it is quick, completely safe, painless, inexpensive, and rich in information.” In part two of this lab, you’ll learn a little bit about such measurements.

One's electrocardiogram is the time-dependent potential difference that the heart generates between selected points on the surface of the body. By measuring your EKG, you can determine the time-dependent electric dipole moment of your heart, which results from the discharging of the cell membranes of the cells of the heart muscle.

Why does the heart have a time-dependent electric dipole moment? The heart is made up of muscle cells. When resting (not contracting), these cells have oppositely charged layers of ions on either side of the cell membrane. These cells have specialized proteins that span across their membranes called ion channels; when the cells contract, the ion channels allow positive ions to flow into the cell and change the potential difference across the membrane (the physiological term for this is “depolarization”). The contraction travels from cell to cell, so the edge of the depolarized region travels across the heart.

The edge of the depolarized region has an electric field like that of an electric dipole (charges of opposite type, separated by some distance). This edge moves as the depolarization spreads across the heart during regular cycles of contraction and expansion. Ultimately, you will measure the motion of this electric dipole when you measure your EKG.

Any changes in heart function, such as diseased regions of the heart muscle that fail to contract properly, will change the moving dipole moment—hence its diagnostic utility.

Purpose

Now that you have read the introduction to this lab, please explain (in two or three sentences) the purpose of each part of this laboratory activity. Why collect this data? What hypotheses might you be exploring when you carry out the measurements proposed in Part One? In Part Two?

Procedure

Part One

In this lab you will measure equipotential lines between two parallel conducting electrodes, and then use your measured equipotential lines to determine the electric field.

The electrodes are made using conductive tape. The strips of tape are placed on special paper that is impregnated with carbon. While carbon is slightly conductive, it is much less conductive than the tape that is used to make the electrodes. When the power supply is connected, charges of opposite type collect on each of the two electrodes. Each entire electrode is essentially at the same potential as the power supply terminal to which it is connected. Because the paper is also conductive, charge carriers can move from one electrode to the other, from high to low potential, just as water flows from regions of high to low gravitational potential. You might wonder why we are measuring supposedly “static” electric fields in a configuration that involves moving charges. Do you have any guesses about why we might do this?

To map out the equipotential lines on the paper, you will use a multimeter to measure the potential difference between a point on the paper and a fixed reference point. To do so, simply touch the probes firmly to the two points of interest.

There are two electrode configurations that you will be exploring in this lab: a parallel configuration and a dipolar configuration.

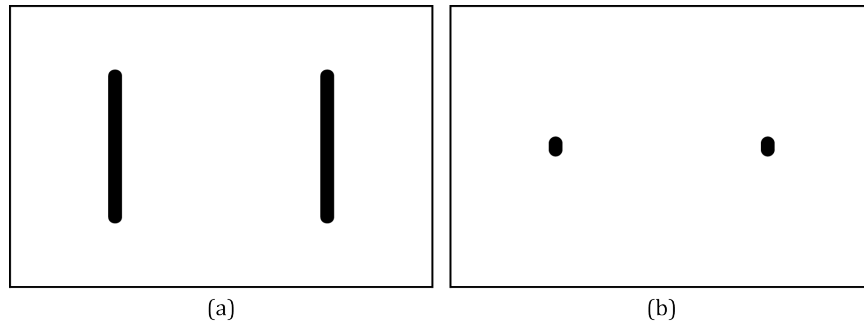

Figure 1: The (a) parallel and (b) dipolar electrode configurations are used in this lab.

Before measuring anything, it is important that you have make some predictions about what you will observe...

Predictions

- Sketch the electric field lines you expect to observe from two parallel conducting sheets when a potential difference is applied between the sheets. Remember to include the type of charge on each sheet, and orient your sketch as a cross-section (that is, represent the sheets as parallel lines, as in Fig. 1a).
- Then sketch the equipotential lines you expect to observe.
- Imagine a line connecting the two sheets, and sketch a graph of the electric potential vs. position along this line, starting at the lower potential. Explain the basis for your prediction. What does the slope of the potential vs. position graph represent?
- Repeat these sketches for the dipolar configuration.

When you have made your predictions, take a minute to chat with your TF about your predictions. Your TF will provide two power supplies, so you can begin making measurements after the discussion. The following procedure should be carried out for each of the two electrode configurations. You should include a diagram of the apparatus in your report (in which all

connections are clearly labeled), and you should include your electrode sheet as part of the collected data.

1. Plug the power supply into the outlet at your table and connect the leads to each of the electrodes. Check that the potential is constant along each electrode; if it is not, ask your TF to help cut a new set of electrodes.
2. To identify the equipotential lines, start by measuring the potential difference between some point and your chosen reference point.
3. Record the specific value of the electric potential relative to the reference point, and then move the probe along the paper while watching the voltmeter display; try to move the probe along a path that keeps the potential constant.
4. While one lab partner moves the probe, another can trace the path followed by the probe with a pencil, or mark a series of equipotential positions with dots close together and then draw a smooth line through the dots after the path has been completed. Take turns using the multimeter and recording the results.
5. It is impossible to keep the potential perfectly constant, so also record how much the meter readings vary as you probe a “single” point along the path. This gives you a sense of your measurement uncertainty.
6. After measuring one equipotential line, label that line with its potential (relative to the reference), find a starting point that corresponds to a different potential, and start another line. Remember to record measurements outside of the region between the electrodes, as well. You should map equipotential lines that correspond to regular voltage intervals, perhaps separated by 0.5 V (this is just an example; if 0.5 V results in either too many or too few lines, choose another separation value).

7. Based on the equipotential map, draw in the electric field lines. Use arrows to represent the direction.
8. Record where the field appears to be strongest and where it appears to be weakest. Remember that the electric field is strongest where the equipotential lines are closest together.
9. To be more quantitative, measure and record the potential (relative to the reference point) at 0.5 cm intervals along the center line between the electrodes.
10. Use LoggerPro or Excel to plot the potential versus the distance between the electrodes, and fit a suitable function to fit it.

You might notice that the electrodes span 12 V, but points on the paper cover a much narrower range; this is because the adhesive between the conductive tape and the paper is not very conductive, so the change in potential across the paper does not represent the full difference in potential between the electrodes (there is some change in potential across the adhesive).

You are welcome to use symmetries of the electrode configuration to speed your work, but clearly explain why you expect these symmetries to be valid. You can measure an equipotential line carefully in one region of the paper, use symmetry to fill out the line elsewhere, and then measure a few points to check that you are right about the symmetry. If not, can you explain the discrepancies?

Now that you have collected data, discuss both your measurements and your predictions.

Analysis

- Are your maps and graphs of potential vs. distance consistent with your predictions? Can you explain the differences? What information do you gain from the fit to your data?

- In the case of the parallel configuration, do you think the two-dimensional configuration you measured is a reasonable model for a slice through a set of parallel plates? Why?
- Would your equipotential lines change if you had chosen a different location to serve as the reference? If so, how would they change?
- Does the potential change as rapidly with distance in the region outside the electrodes as it does in the region between the electrodes? Is this consistent with the electric field you predicted?
- The SI unit for the electric field is volts/meter. Dividing the potential difference between the electrodes by the distance between the electrodes, what is the average magnitude of the electric field between the electrodes (with uncertainty)? Is this magnitude the same as the slope of the potential versus distance plot? Why or why not?

Once you have finished analyzing this data, carry out the following additional measurement.

1. Construct a ring out of a single piece of conductive tape and press it down firmly between the two electrodes already on your “parallel configuration” paper.
2. Apply a potential difference between the plate electrodes using the power supply; do not connect anything to the ring electrode.
3. Make a prediction: do you expect the electric field lines and equipotential lines to change? If so, how? Based on your previous measurements, what potential difference(s) between the center disk and the reference point do you expect to measure?
4. Record and plot the potential as a function of distance along the line between the electrodes (this line should now pass through the conducting ring), and map the equipotential lines between the plates and the ring.

Further Analysis

- Compare your predicted and measured equipotential lines and electric field lines, and explain what might have caused the differences.
- What is the electric potential inside the ring? Does it vary with position? Provide a diagram showing how charge is distributed on the conducting ring.
- What is the electric field inside the ring? Why?
- How does the electric field outside the ring compare to the field you measured before inserting the ring? Give a physical explanation for any difference, if you can.
- How you could estimate the strength of the electric field at a particular point on your map based on the measured equipotential values and positions? Think about how you calculated the electric field for the parallel electrode configuration.

Part Two

Now that you have explored the relationship between electric fields and electric potential differences, you will carry out a measurement that has enormous utility in medicine.

Each EKG sensor has three “leads,” or wires, connected to it: red, black, and green. The sensor measures potential difference from the green to the red lead. In other words, if the red lead is at higher potential than the green, the reading will be positive; if the red is at lower potential than the green, the reading will be negative. The black lead serves as the zero of potential; when you zero the ECG sensors, the reading from the black lead is used as “zero.” This is equivalent to the “ground” terminal on the power supplies. The black lead acts as a reference so that multiple sensors can be used simultaneously, all with the same zero.

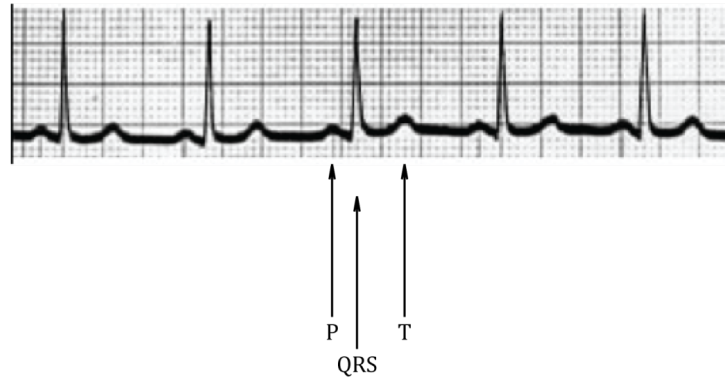

Figure 2: The P, QRS and T peaks are labeled on this actual EKG measurement.

Figure 2 shows an actual EKG measurement with the different features labeled using electrocardiography nomenclature. The peak labeled P corresponds to the initial electrical pulse triggering the heart's contraction. The interval from P to Q corresponds to the spreading of the depolarization across the smaller chambers of the heart (the atria), and is typically very small because the atria are only a small fraction of the heart (see heart image at end of lab). The interval from Q to S, called the "QRS complex" and usually the biggest part of the signal, comes from contraction of the large chambers (ventricles) of the heart; these chambers accomplish most of the pumping. Finally, the T peak is associated with the repolarization, or recharging, of the ventricles in preparation for the next cycle. (Repolarization of the atria occurs during the contraction of the ventricles and is hidden by the QRS complex.)

Clinically, each potential difference is referred to as a "Lead" (short for a pair of leads). The two potential differences we will measure are called "Lead I" and "Lead II" and are shown in Figure 3. The red lead is attached to the "+" end of the sensor and the green lead to the "-" end of the sensor.

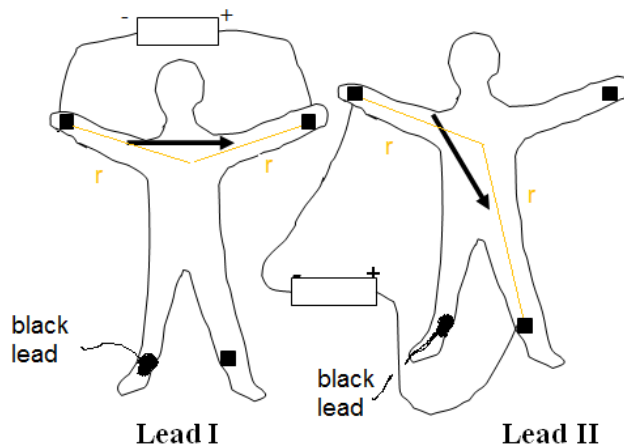

Figure 3: These are two electrocardiography measurement configurations.

Lead I measures the potential difference between two points that fall along a horizontal line, and thus is generated by the x-component of the dipole moment of the heart. Because of how the heart's electric field spreads to the limbs, the line between the Lead II points is approximately 60 degrees to the horizontal. As described further in the separate "Analysis" handout, vector analysis allows you to combine Lead I and Lead II to determine the vertical (y-component) of the dipole moment of the heart.

In clinical electrocardiography, twelve potential differences are measured. In this lab, however, you will measure just two in order to determine the dipole moment of the heart in the plane shown in Figure 3. For all measurements, the black reference lead is attached to the right ankle. The EKG setup measures the potential difference between the red and green leads as a function of time. You will measure both "Lead I" and "Lead II" potential differences versus time and, from these data, determine the direction of the peak dipole moment of the heart. The ECG measurements are made using LoggerPro.

Predictions

Do you expect "Lead I" and "Lead II" to be different from one another? In what way(s)? Why?

Single lead ECG measurement

1. Connect one ECG sensor to the Ch1 input on the USB interface box. The sensor should be automatically recognized by the computer when you launch the LoggerPro software.
2. Under Experiment -> Data Collection, set the sampling rate to 250 samples/second, so that a data point is measured every 0.004 s. Ignore Logger Pro's warning that this is faster than recommended.
3. The leads have so-called "alligator clips" on their end which can be clipped onto the tabs on the sticky gel electrode patches that attach to the skin of the "patient". Before attaching the electrode patches, use alcohol wipes or soap and water to clean the skin where they are to be attached, since skin oils will degrade the electrical contact.
4. One member of the lab group (the "patient") should attach electrode patches in the four positions (right and left ankles and right and left shoulders/upper arms) and then connect the ECG sensor in the "Lead I" configuration (Figure 3).
5. Zero the sensor in Logger Pro and then measure an EKG.
6. Record the overall amplitude and duration of the QRS complex. The amplitude should be a few mV and the duration should be 60-80 ms. Note that the values pointed to by the cursor show up at the bottom of the plot itself at right, not in the large display at the bottom-left corner.
7. Record what happens to the signal if you swap the green and red alligator clips. Clinically, this is referred to as "lead reversal."
8. Record what happens if the black "ground" lead is disconnected.

9. Switch to the “Lead II” configuration and record a single-lead EKG. Note its duration and amplitude.

Your data should look something like those shown in Figure 2. The repetition in the signal reflects the heart’s repeated contraction.

Peak electric dipole moment of the heart

10. Obtain a second ECG sensor and connect both “Lead I” and “Lead II” configurations *simultaneously* on one person. Share sensors with another group as needed. In both cases the black reference lead is connected in the same place.
11. Zero both sensors.
12. Measure both lead configurations simultaneously.
13. Check that the baseline level of the two signals (before the beginning of a P wave) is close to zero; if either of the signals has a nonzero baseline, create new columns of data in which you subtract the baseline level from the signal.
14. Calculate $\text{Lead II} - (\text{Lead I})/2$ in a new column in Logger Pro (Data -> Calculate Column) which is related to the y-component of the dipole moment. (The x-component of the dipole moment is simply related to Lead I as discussed in the “analysis” handout.)
15. Make a new graph showing the x-component and y-component data vs. time.

Analysis

- For which of the two lead configurations is the amplitude of the QRS complex greatest?
How do the two signals differ or resemble each other?

- At the instant when the largest lead is at its peak, find the voltage of the other lead configuration (not necessarily its peak).
- Use these two signals to find the direction of the electric dipole of the heart at this peak. The electric dipole moment of the heart \mathbf{p} is a vector; it can be written as the sum of components, p_x , p_y , and p_z . As discussed on the “analysis” handout, p_x and p_y are proportional to the “Lead I” and “Lead II - (Lead I)/2” measurements, respectively. We can’t easily measure the p_z component of the dipole today, since you’d have to take off your shirt to measure the voltage from front to back.

The relationships are:

Horizontal:

$$\Delta V_{horizontal} = \Delta V_{Lead_I} = V(r,0,0) - V(-r,0,0) = \frac{P_x}{2\pi\epsilon_0\kappa_{water}r^2}$$

Vertical:

$$\Delta V_{vertical} = \Delta V_{Lead_II - Lead_I/2} = V(0,r,0) - V(0,-r,0) = \frac{P_y}{2\pi\epsilon_0\kappa_{water}r^2}$$

For your calculations, make a reasonable estimate for the distance r from the center of the chest cavity to the point where the potential is measured. The dielectric constant of water, κ_{water} , is about 80. From your data, determine p_x and p_y , and determine the magnitude and direction of your heart’s peak electric dipole moment in the xy -plane. Do you should find a value on the order of 10^{-13} Cm?

16. Make a sketch showing the orientation of your peak dipole moment on the chest (something like the figure shown below).

How does its direction compare with the Figure 5, which shows the path followed by the dipole moment of the heart?

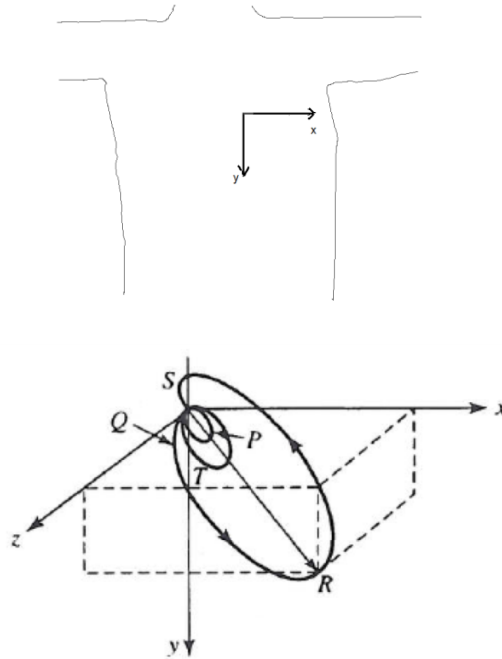

Figure 5: Example of path followed by the tip of the cardiac dipole moment $\mathbf{p}(t)$ during a cardiac cycle. The vector $\mathbf{p}(t)$ is shown at the peak instant pointing to R . From Benedek & Villars, *Physics with Illustrative Examples from Medicine and Biology*, AIP Press-Springer, 2000.

Don't forget to include...

- Written responses to all analysis questions
- Carbon paper with measured equipotential lines and electric field lines (make sure the equipotentials are labeled with potential values)
- Plots of potential vs. distance with fits for all configurations
- Printout of the ECG data from the two simultaneous measurements
- Calculation of the magnitude and direction of heart's dipole moment at the peak signal, the sketch of the direction of the dipole vector on a chest, and a brief discussion of how they compare.

If time permits...

Use the electrostatics simulation on the lab computer to simulate a dipole, showing both equipotential lines and electric field vectors. Print out the result. Compare the simulation result with your measured result. Are there any discrepancies between the simulation and your measurements, and if so, can you account for the differences?

B.2 Laboratory 2 – Capacitance

(developed from activities in Matter and Interactions, by Ruth Chabay and Bruce Sherwood, and materials introduced by the Rutgers Physics and Astronomy Education Research Group)

Scientific Ability Rubrics

A7, B1, B3, B6, B7, B9, C2, C4, C5, C8, C9, D2, D7, D8, D9, F1, G1, G2, G3, G4, and G5

Goals

After successfully completing this lab, you will be able to:

- 1) develop hypotheses related to the charge storage properties of capacitors
- 2) design and carry out experiments to test such hypotheses

Introduction

This week, you will investigate the charging and discharging of capacitors. You will observe this first qualitatively using a light bulb, and then conduct several experiments to test hypotheses and apply what you've learned to discover an unknown quantity.

I Observational Experiment: Probing Capacitance Using a Light Bulb

Available Equipment

capacitor, batteries, wires, switch, short bulbs, long bulbs

You can certainly charge a capacitor by connecting it directly to a source of charges (a battery), but you cannot “see” anything happening. However, with a light bulb between the battery and the capacitor, you can see the charging much more clearly because the bulb glows when charges are moving through the filament.

Design an experiment to investigate *qualitatively* how the charging and discharging of a capacitor depends on the bulb that is connected between the capacitor and the battery.

- a) Describe your experimental procedure. Include a labeled sketch. Make sure that you identify the independent and dependent variables.
- b) What assumptions are you making? Are any of them particularly questionable assumptions? How will you minimize the effect of them?
- c) Perform your experiment. Describe your observations with words and using diagrams.
- d) Use your observations to determine how the charging of the capacitor depends on the bulb that is used. Describe the reasoning you used.
- e) Suggest an experiment that would allow you to investigate the same phenomenon *quantitatively*. You may use equipment other than what is listed above.

II Testing Experiment: Differing Hypotheses about Capacitance

Available Equipment

capacitor, batteries, wires, switch, voltmeter, short bulbs, long bulbs, stopwatch

Does the final amount of charge on the capacitor plates depend on which bulb was used during the charging process?

Your friend Andy notices that charging the capacitor through the long bulb goes on much longer than charging through the short bulb, so he thinks that the capacitor is actually getting charged up a lot more when the long bulb is used. Your other friend, Beth, suspects that, because the short bulb glows much more brightly, the capacitor is getting charged up a lot more when the short bulb is used.

Consequently, Andy hypothesizes that the capacitor carries more charge when the long bulb is used, and Beth hypothesizes that the capacitor carries more charge when the short bulb is used.

Design a set of experiments to test Andy and Beth's hypotheses. Remember, the goal of a testing experiment is to disprove a hypothesis if you can. This is a significantly more powerful step in the scientific process than merely finding another piece of supporting evidence.

Include the following in your lab report:

- a) Briefly describe some (at least two) observations (involving only the available equipment!) you would expect to make if Andy's hypothesis were true. Similarly, describe two observations you would expect to make if Beth's hypothesis were true.
- b) Describe your experimental procedures, which should relate to each of your observations. Include a labeled diagram of your setup(s). Make sure that you identify the independent and dependent variables.

- c) What does Andy's hypothesis predict will happen when you perform the experiment(s)?
What does Beth's hypothesis predict will happen? This is the first part of what is known as hypothetico-deductive reasoning: "If Andy's idea is correct, and I do [A], then [B] should happen."
- d) Describe any assumptions you made in making your prediction(s). How do these assumptions affect your prediction(s)? How might they hinder your ability to make a judgment about the hypotheses?
- e) List sources of experimental uncertainty. Which are the largest? How can you minimize them?
- f) Perform the experiment and describe your results in words and with a table.
- g) What is your judgment about Andy's hypothesis? And Beth's hypothesis? This is the second part of hypothetico-deductive reasoning: "This did/didn't happen, so therefore..."

III Application Experiment: Measuring Unknown Capacitance

The goal of this experiment is to determine the capacitance of an unknown capacitor.

Available Equipment

unknown capacitor, known capacitor, wires, voltmeter, battery (or power supply)

- a) Devise a way to determine this and write an outline of your procedure. Include a labeled diagram of your setup.
- b) Describe the mathematical procedure you will use to determine the unknown capacitance. Include a diagram, if needed.

- c) List the assumptions you are making. Why do you think these assumptions are valid?
Explain how each assumption could affect the outcome (as in, will it make the measured capacitance smaller, larger or randomly different than the actual value?)
- d) List sources of experimental uncertainty. What is the largest source of uncertainty in the result? How can you minimize it?
- e) Perform the experiment. Make sure you take steps to minimize the uncertainties. Record your observations in an appropriate format. Make a table if necessary.
- f) What is the result of your experiment? How does it compare to the capacitance measured directly using a capacitance meter? Make sure you consider uncertainty when you compare those values.

IV Testing Experiment: Relating Parameters to Capacitance

Available Equipment

large plates, wires, capacitance meter, voltmeter, ruler, battery (or power supply)

The goal of this experiment is to test whether the rule

$$C = \frac{q}{V} = \frac{\epsilon_0 A}{d}$$

is applicable in this specific case. Remember that the purpose of testing is to reject (if possible), not to support the rule under test.

Write the following in your report:

- a) State what rule you are going to test.

- b) Brainstorm the task and make a list of possible experiments whose outcome can be predicted with the help of the rule. After making your list, discuss the options with your TF before continuing.
- c) Briefly describe your chosen design. Include a labeled sketch. Make sure that you identify the independent and dependent variables.
- d) Use the rule being tested to make a prediction about the outcome of the experiment. Explicitly mention any assumptions you are making, and describe their effect on your prediction.
- e) List sources of experimental uncertainty. What is the largest source of uncertainty in the result? How can you minimize it?
- f) Perform the experiment. Record the outcome.
- g) Is the outcome consistent or inconsistent with the prediction? Explain in detail how you decided this.
- h) Based on the prediction and outcome of the experiment, what is your judgment about the rule being tested? Does it apply in this specific case?
- i) Talk to your classmates in other lab groups and find out what results they have. Are they consistent with yours?

Why did we do this lab?

Write a brief paragraph explaining what you have learned about capacitors in these laboratory activities. What do you think the differences between an observational, testing and application experiment are?

If time permits...

1. How bright is the bulb initially, compared to a circuit containing just a battery and a bulb?
2. During discharging, why does the bulb get dimmer and dimmer?
3. When the light bulb is glowing, do electrons flow across the gap in the capacitor?

B.3 Laboratory 3 (scaffolded) – Magnetism

(developed from materials introduced by the Rutgers Physics and Astronomy Education Research Group)

Scientific Ability Rubrics

A5, C1, C2, C3, C4, C5, C6, C7, C8, F1, G1, G2, G3, G4, and G5

Goals

After successfully completing this lab, you will be able to:

- 1) use the available equipment to design an experiment to reach a desired goal
- 2) apply your knowledge to solve problems in magnetism

In these laboratory activities, you will generate currents in order to observe magnetic interactions. As Prof. [X] mentioned in class, large currents can cause significant damage to power supplies if too much current passes through them for too long; in some cases, wires will begin to melt and the power supply may even explode! Therefore, to limit the current flowing through wires in this lab, make sure you include a resistor in any current loop you set up.

Resistance impedes the flow of electrons and reduces the total current through the wire. The

relationship between current and resistance will be further discussed in Unit 8, but it is introduced in this lab because of the important role it plays in controlling current.

I Testing Experiment: Force on a current-carrying wire due to a magnet

Available Equipment

neodymium magnets, assorted wires, a scale, a voltage source, assorted posts and clamps, an aluminum rod, several resistors

Think of how you can use this equipment to test the right-hand rule for the direction of the force exerted by a magnetic field on a current carrying wire (the so-called “right-hand force rule”).

Also, think of what physical quantities you could determine using the scale.

Warning: Do not leave the voltage source on after you finish the measurements.

- a) First, recall the right hand rule for the magnetic force. Write what quantities it relates and express it with a picture or using words. Consider the available equipment and how you could use it to achieve the goal of the experiment. Brainstorm and write down your ideas including what you could measure and sketches of possible experimental setups.
- b) Describe your procedure. The description should contain a labeled sketch of your experimental set-up, an outline of what you plan to do, what you will measure, how you will measure it. Explain how you will use the reading of the scale to determine the force exerted by the wire on the magnet, and the force exerted by the magnet on the wire. To help, use free-body diagram(s) and Newton’s second and third laws.
- c) Make a qualitative prediction for the reading of the scale (more than some value, less than some value) for your particular arrangement. Show the reasoning used to make the

prediction with free-body diagrams. Call your TA over once you have done this but before you turn on the current. Then perform the experiment and record the outcome.

- d) List sources of experimental uncertainty. What is the largest source of uncertainty in the result? How can you minimize it?
- e) Did the outcome match your prediction? If not, list possible reasons.
- f) Based on your prediction and the experimental outcome, make a judgment about the right-hand rule.

II Observation experiment: Invent your own investigation

Available Equipment

neodymium magnets, assorted wires, a scale, a voltage source, assorted posts and clamps, an aluminum rod, several resistors, a variable resistor, an ammeter, shims

What mathematical relationship between physical quantities could you investigate using the available equipment? Pose a question, investigate it, and write a brief summary of the results of the investigation. Include a statement of the mathematical relationship you found.

III Testing experiment: Does a coil behave like a magnet?

Available Equipment

neodymium magnets, assorted wires, a voltage source, assorted posts and clamps, a coiled wire, a compass, several resistors

Your friend Luis has an idea that a coil of wire with current flowing in it behaves like a bar magnet whose poles can be determined using the right-hand current rule. Design an experiment to test his idea.

- a) First recall what the “right-hand current rule” says. Decide how you can apply it to determine the shape of the magnetic field of a current carrying coil.
- b) Design an experiment to test Luis’ idea. Describe your procedure and draw a sketch of your experimental setup.
- c) Using Luis’ idea, make a prediction of the outcome of the experiment. Explain the reasoning used to make the prediction in detail. What assumption do you need to make the prediction?
- d) Use the wire to make a coil with several turns. Conduct the experiment and record the outcome.
- e) Did the outcome match the prediction?
- f) What is your judgment about Luis’ idea?

IV Testing Experiment: Magnetic field of a current-carrying wire

Available Equipment

assorted wires, assorted compasses, a voltage source, assorted posts and clamps, a protractor, several resistors, an ammeter

In Experiment I, you explored the relationship between force and current. Here, you will explore the relationship between magnetic field and current. Using these materials and what you know

about the direction of the magnetic field around a wire, how might you be able to quantify the strength of the magnetic field generated by a wire?

Write the following in your report:

- a) State what rule you are going to test.
- b) Brainstorm the task and think of some measurements you could make. Discuss the options with your TF before continuing.
- c) Briefly describe your chosen design. Include a labeled sketch. Make sure that you identify the independent and dependent variables.
- d) Use the rule being tested to make a prediction about the outcome of the experiment. Explicitly mention any assumptions you are making, and describe their effect on your prediction.
- e) List sources of experimental uncertainty. What is the largest source of uncertainty in the result? How can you minimize it?
- f) Perform the experiment. Record the outcome.
- g) Is the outcome consistent or inconsistent with the prediction? Explain in detail how you decided this.
- h) Based on the prediction and outcome of the experiment, what is your judgment about the rule being tested? Does it apply in this specific case?

Why did we do this lab?

What was the purpose of using free-body diagrams in this lab? Describe the instances when the diagrams helped you make decisions related to the collection of your data and the analysis.

What steps did you take to minimize the experimental uncertainty in the measurement of the current in experiment II?

Why was it important to consider the assumption you made in experiment III?

B.4 Laboratory 3 (exploratory) – Magnetism

(developed from materials introduced by the University of Maryland Physics Education Research Group)

Scientific Ability Rubrics

A5, C1, C2, C3, C4, C5, C6, C7, C8, F1, G1, G2, G3, G4, and G5

Goals

After successfully completing this lab, you will be able to:

- 1) use the available equipment to design an experiment to reach a desired goal
- 2) apply your knowledge to solve problems in magnetism

In these laboratory activities, you will generate currents in order to observe magnetic interactions. As Prof. [X] mentioned in class, large currents can cause significant damage to power supplies if too much current passes through them for too long; in some cases, wires will begin to melt and the power supply may even explode! Therefore, to limit the current flowing through wires in this lab, make sure you include a resistor in any current loop you set up.

Resistance impedes the flow of electrons and reduces the total current through the wire. The relationship between current and resistance will be further discussed in Unit 8, but it is introduced in this lab because of the important role it plays in controlling current.

Question

What is the direction of the force on a current-carrying wire due to a magnet?

Quantitatively describe the relationship between the force on the magnet and the current through the wire. Use whatever tools and techniques you'd like, as long as they can be explained to the rest of the class during discussion.

Available Equipment

neodymium magnets, assorted wires, a scale, a voltage source, assorted posts and clamps, an aluminum rod, several resistors, an ammeter, shims

Warning: Do not leave the voltage source on after you finish the measurements.

Timetable

1. Pre-Lab Discussion - 20 min - Whole class
2. Planning the Experiment (Q1) - 20 min - Groups
 - How are you going to illustrate your data?
 - How are you accounting for uncertainty in the measurements?
 - What seems to be the behavior or features of this relationship?
 - How can you quantify this relationship so that it can be communicated to others?
3. Data Collecting (Q1) - 20 min - Groups
4. Class Discussion (Q1 and Q2) - 20 min - Whole Class
5. More Data Collecting (Q2) - 20 min – Groups

6. Data Analysis (Q1 and Q2) - 40 minutes - Groups
7. Writing the Report (Q1 and Q2) - 30 minutes - Groups

B.5 Laboratory 4 (scaffolded) – Electromagnetic Induction

(developed from materials introduced by the Rutgers Physics and Astronomy Education Research Group)

Scientific Ability Rubrics

B2, B4, B9, C4, C6, C8, F1, and G1

Goals

After successfully completing this lab, you will be able to:

- 1) determine the conditions under which a current can be induced in a coil that is not connected to a battery;
- 2) determine which physical quantities affect the magnitude of the induced current;
- 3) record data carefully and identify patterns; and
- 4) revise a rule when new observations are made.

In these laboratory activities, you will generate currents in order to observe magnetic interactions. As Prof. [X] mentioned in class, large currents can cause significant damage to power supplies if too much current passes through them for too long; in some cases, wires will begin to melt and the power supply may even explode! Therefore, to limit the current flowing through wires in this lab, make sure you include a resistor and a switch in any current loop you

connect to a voltage supply. Also, please remember to turn off voltage supplies when you are not using them.

You will use galvanometers and voltage supplies in these activities. **The galvanometer must never be placed in the same circuit as the voltage supply; they must be completely disconnected from one another.** The galvanometer is extremely sensitive and will be instantly damaged if it is connected to the voltage supply in any way.

I Observation experiment: Using a magnet to induce a current in a coil

Available Equipment

neodymium magnets, a coiled wire, a galvanometer, connecting wires

Your goal is to design as many experiments as possible to cause a current (also called ‘inducing a current’) in a coil of wire that is not connected to a battery. Even though these experiments are qualitative in nature, be specific and precise with what you do.

- a) First, decide how you would set-up the experiment to detect if there is current in the coil.

Hint: The galvanometer needle will deflect if a current flows through it.

- b) Draw a sketch for each experiment you perform. Briefly describe what you did. Indicate whether there was current induced in the coil or not.
- c) Develop a rule: Devise a preliminary rule that summarizes the list of conditions needed to induce a current in a coil.

II Testing experiment: Does a coil behave like a magnet?

Available Equipment

two coils, assorted connecting wires, a voltage source (with resistors and switch), a galvanometer

In the previous lab you may have attempted to disprove the hypothesis that a coil of wire with current behaves like a bar magnet. Keep trying! Design experiments using this equipment to try to disprove this idea. *Hint: Use your knowledge about the properties of magnets to induce current in a coil using a second coil instead of a magnet.*

- a) Design as many experiments as you can (at least two) to test the idea.

For each experiment:

- b) Describe your experimental procedure and include a labeled diagram
- c) Using the idea you are testing make a prediction of the outcome of the experiment.
- d) Conduct the experiment and record the outcome.
- e) Did the outcome match your prediction?

What is your judgment about the idea?

III Observation experiment: Inducing a current in a coil

Available Equipment

2 coils, a voltage source (with resistors and switch), connecting wires, a galvanometer

One of the coils is connected to the voltage source, and the other is not. Your goal is to design an experiment to induce current in the coil that is not connected to the voltage source, without moving either coil.

- a) Describe your experimental procedure. Include a labeled diagram.
- b) Indicate whether there was current induced in the coil or not.
- c) Develop a rule: Revise the rule you devised in experiment I by devising a more general rule that summarizes the results of the observations from experiments I and III. *Hint: Think about this rule in terms of the magnetic field.*

IV Observation experiment: Magnitude of induced current

Available Equipment

neodymium magnets, coils with varying number of windings, a galvanometer, a voltage source (with resistors and switch)

By now, you know how to use a magnet to induce a current in the coil. Your goal for this set of experiments is to devise a qualitative rule that relates the magnitude of induced current to the properties of the magnet, the motion of the magnet, and the properties and the orientation of the coil.

- a) Briefly describe each experiment using a sketch or words.
- b) Come up with as complete a list as possible of factors that affect the magnitude of the current induced in the coil.
- c) Summarize the factors that affect the magnitude of the induced current. Devise a qualitative rule (in words) that relates the magnitude of induced current to other factors.

Hint: Think about this rule in terms of the magnetic field.

V How does a galvanometer work?

Available Equipment

a galvanometer

- a) Play with the galvanometer.
- b) Discuss how the galvanometer works with your group and with your TA.
- c) Is your understanding of a galvanometer work consistent now with your previous knowledge? If not, why?

Why did we do this lab?

Summarize your findings:

- What are the conditions under which a current can be induced in a coil that is not connected to a battery?
- What are the factors that affect the magnitude of the induced current?

When several factors affect some physical quantity, what is the general strategy that you would use to determine the effect of each of them?

B.6 Laboratory 4 (exploratory) – Electromagnetic Induction

(developed from materials introduced by the University of Maryland Physics Education Research Group)

Scientific Ability Rubrics

B2, B4, B9, C4, C6, C8, F1, and G1

Goals

After successfully completing this lab, you will be able to:

- 1) determine the conditions under which a current can be induced in a coil that is not connected to a battery;
- 2) determine which physical quantities affect the magnitude of the induced current;
- 3) record data carefully and identify patterns; and
- 4) revise a rule when new observations are made.

In these laboratory activities, you will generate currents in order to observe magnetic interactions. As Prof. [X] mentioned in class, large currents can cause significant damage to power supplies if too much current passes through them for too long; in some cases, wires will begin to melt and the power supply may even explode! Therefore, to limit the current flowing through wires in this lab, make sure you include a resistor and a switch in any current loop you connect to a voltage supply. Also, please remember to turn off voltage supplies when you are not using them.

You will use galvanometers and voltage supplies in these activities. **The galvanometer must never be placed in the same circuit as the voltage supply; they must be completely disconnected from one another.** The galvanometer is extremely sensitive and will be instantly damaged if it is connected to the voltage supply in any way.

Question

Describe several different ways can you induce a current in a coil. How does the magnitude of the induced current depend on properties – position, motion, orientation, etc. – of the materials that are used?

Available Equipment

neodymium magnets, several coiled wires, a galvanometer, a voltage source (with resistors and switch), connecting wires

Timetable

1. Pre-Lab Discussion - 20 min - Whole class
2. Planning the Experiments - 20 min - Groups
 - How are you going to illustrate your data?
 - How are you accounting for uncertainty in the measurements?
 - What seems to be the behavior or features of this relationship?
 - How can you quantify this relationship so that it can be communicated to others?
3. Data Collecting - 20 min - Groups
4. Class Discussion - 20 min - Whole Class
5. More Data Collecting - 20 min – Groups
6. Data Analysis - 40 minutes - Groups
7. Writing the Report - 30 minutes - Groups

B.7 Laboratory 5 – DC Circuits

(developed from materials introduced by the University of Maryland Physics Education Research Group)

Scientific Ability Rubrics

B7, C2, C5, C6, C7, F1, G2, and G5

Goals

After successfully completing this lab, you will be able to:

- 1) determine whether a particular trend is exhibited by collected data; and
- 2) establish a rule, based on data, and apply it when appropriate.

There are some materials that conduct electricity so that the *current* that flows through them is *linearly proportional* to the applied *voltage*. Such a material is called “Ohmic.” If you know that a material is Ohmic, you can tell what the current is just by knowing how much voltage you are applying. Predictability is important for certain electrical hardware.

Question

Is an electrical resistor Ohmic? Is a light bulb Ohmic? Propose a “rule” that determines whether data is linear or not. According to this rule, are any of your other materials Ohmic?

Available Equipment

a voltage source, an ammeter, a voltmeter, a switch, a light bulb, several resistors, connecting wires, diode, additional wires of various types, water, salt, a beaker

Timetable

1. Pre-Lab Discussion - 20 min - Whole class
2. Planning the Experiment - 20 min - Groups
 - How are you going to illustrate your data?
 - How are you accounting for uncertainty in the measurements?
 - What seems to be the behavior or features of this relationship?
 - How can you quantify this relationship so that it can be communicated to others?
3. Data Collecting - 20 min - Groups
4. Class Discussion - 20 min - Whole Class
5. More Data Collecting - 20 min – Groups
6. Data Analysis - 40 minutes - Groups
7. Writing the Report - 30 minutes - Groups

Appendix C

Scientific Ability Rubrics

These rubrics were developed by and are reproduced with permission of the Rutgers Physics and Astronomy Education Research Group.

Scoring Key

- 1) Missing
- 2) Inadequate
- 3) Needs some improvement
- 4) Adequate

C.1 Rubric A: Ability to represent information in multiple ways

A1 Is able to extract the information from representation correctly

- 1) No visible attempt is made to extract information from the problem.
- 2) Information that is extracted contains errors such as labeling quantities incorrectly.
- 3) Some of the information is extracted correctly, but not all of the information.

Numbers are just extracted with correct labels but no units are extracted with them.

- 4) All necessary information has been extracted correctly and is visible through a constructed representation.

A2 Is able to construct new representations from previous representations

- 1) No attempt is made to construct a different representation.
- 2) Representations are attempted, but use incorrect information or the representation does not agree with the information used.
- 3) Representations are created without mistakes, but there is information missing, i.e. labels, variables.
- 4) Representations are constructed with all given (or understood) information and contain no major flaws.

A3 Is able to evaluate the consistency of different representations and modify them when necessary

- 1) No representation is made to evaluate the consistency.
- 2) At least one representation is made but there are major discrepancies between the constructed representation and the given one.

- 3) Representations created agree with each other but may have slight discrepancies with the given representation. Can be seen that modifications were made to a representation.
- 4) All representations, both created and given, are in agreement with each other.

A4 Is able to use representations to solve problems

- 1) No attempt is made to answer the problem.
- 2) Question is answered incorrectly.
- 3) Question is answered correctly without the use of a representation.
- 4) Question is answered correctly with the use of a representation other than a mathematical.

Representations students can make

A5 Free-Body Diagram

- 1) No representation is constructed.
- 2) FBD is constructed but contains major errors such as incorrect mislabeled or not labeled force vectors, length of vectors, wrong direction, extra incorrect vectors are added, or vectors are missing.
- 3) FBD contains no errors in vectors but lacks a key feature such as labels of forces with two subscripts or vectors are not drawn from single point or axes are missing.
- 4) The diagram contains no errors and each force is labeled so that it is clearly understood what each force represents.

A6 Motion Diagram

- 1) No representation is constructed.
- 2) Diagram does not show proper motion, because lengths of arrows are incorrect or missing and/or spacing of dots is incorrect.
- 3) Diagram has no errors but is missing a key feature such as dots that represent position or velocity arrows or velocity change arrows.
- 4) The diagram contains no errors and it clearly describes the motion of the object.

A7 Picture

- 1) No representation is constructed.
- 2) Picture is drawn but it is incomplete with no physical quantities labeled, or important information is missing, or it contains wrong information, or coordinate axes are missing.
- 3) Picture has no incorrect information but has either no or very few labels of given quantities. Majority of key items are drawn in the picture.
- 4) Picture contains all key items with the majority of labels present.

A8 Energy Bar Chart

- 1) No representation is constructed.
- 2) Bar chart is either missing energy values, values drawn do not show the conservation of energy or are drawn in the wrong places. Bar chart levels could also be labeled incorrectly

- 3) Bar chart has the energy levels drawn correctly, but is missing labels. Energy levels could be in the correct spot, but may not be of proper relative size.
- 4) Bar chart is properly labeled and has energy levels at appropriate magnitudes.

A9 Mathematical

- 1) No representation is constructed.
- 2) Mathematical representation lacks the algebraic part (the student plugged the numbers right away) has the wrong concepts being applied, signs are incorrect, or progression is unclear. The first part should be applied when it is appropriate.
- 3) No error is found in the reasoning, however they may not have fully completed steps to solve problem or one needs effort to comprehend the progression.
- 4) Mathematical representation contains no errors and it is easy to see progression of the first step to the last step in solving the equation.

A10 Ray Diagram

- 1) No representation is constructed.
- 2) The rays that are drawn in the representation do not follow the correct paths. Object or image may be located at wrong position.
- 3) Diagram is missing key features but contains no errors. One example could be the object is drawn with the correct lens/mirror but rays are not drawn to show image. Or the rays are too far from the main axis to have a small-angle approximation.
- 4) Diagram has object and image located in the correct spot with the proper labels. Rays are correctly drawn with arrows and contain at least two rays.

C.2 Rubric B: Ability to design and conduct an observational experiment

B1 Is able to identify the phenomenon to be investigated

- 1) No phenomenon is mentioned.
- 2) The description of the phenomenon to be investigated is confusing, or it is not the phenomena of interest.
- 3) The description of the phenomenon is vague or incomplete.
- 4) The phenomenon to be investigated is clearly stated.

B2 Is able to design a reliable experiment that investigates the phenomenon

- 1) The experiment does not investigate the phenomenon.
- 2) The experiment may not yield any interesting patterns.
- 3) Some important aspects of the phenomenon will not be observable.
- 4) The experiment might yield interesting patterns relevant to the investigation of the phenomenon.

B3 Is able to decide what parameters are to be measured and identify independent and dependent variables

- 1) The parameters are irrelevant.
- 2) Only some of parameters are relevant.
- 3) The parameters are relevant. However, independent and
- 4) The parameters are relevant and independent and dependent

B4 Is able to describe how to use available equipment to make measurements

- 1) At least one of the chosen measurements cannot be made with the available equipment.
- 2) All chosen measurements can be made, but no details are given about how it is done.
- 3) All chosen measurements can be made, but the details of how it is done are vague or incomplete.
- 4) All chosen measurements can be made and all details of how it is done are clearly provided.

B5 Is able to describe what is observed without trying to explain, both in words and by means of a picture of the experimental set-up.

- 1) No description is mentioned.
- 2) A description is incomplete. No labeled picture is present. Or, observations are adjusted to fit expectations.
- 3) A description is complete, but mixed up with explanations or pattern.
- 4) Clearly describes what happens in the experiments both verbally and by means of other representations.

B6 Is able to identify the shortcomings in an experimental and suggest improvements

- 1) No attempt is made to identify any shortcomings of the experimental.
- 2) The shortcomings are described vaguely and no suggestions for improvements are made.

- 3) Not all aspects of the design are considered.
- 4) All major shortcomings of the experiment are identified and reasonable suggestions for improvement are made.

B7 Is able to identify a pattern in the data

- 1) No attempt is made to search for a pattern
- 2) The pattern described is irrelevant or inconsistent with the data
- 3) The pattern has minor errors or omissions
- 4) The patterns represents the relevant trend in the data

B8 Is able to represent a pattern mathematically (if applicable)

- 1) No attempt is made to represent a pattern mathematically.
- 2) The mathematical expression does not represent the trend.
- 3) No analysis of how well the expression agrees with the data is included, or some features of the pattern are missing.
- 4) The expression represents the trend completely and an analysis of how well it agrees with the data is included.

B9 Is able to devise an explanation for an observed pattern

- 1) No attempt is made to explain the observed pattern.
- 2) An explanation is vague, not testable, or contradicts the pattern.
- 3) An explanation contradicts previous knowledge or the reasoning is flawed.
- 4) A reasonable explanation is made.

B10 Is able to identify the assumptions made in devising the explanation

- 1) No attempt is made to identify any assumptions.
- 2) The assumptions are irrelevant or incorrect.
- 3) Some significant assumptions are not mentioned.
- 4) Most significant assumptions are correctly identified.

C.3 Rubric C: Ability to design and conduct a testing experiment

(testing an idea/hypothesis/explanation or mathematical relation)

C1 Is able to identify the hypothesis to be tested

- 1) No mention is made of a hypothesis.
- 2) An attempt is made to identify the hypothesis to be tested but is described in a confusing manner.
- 3) The hypothesis to be tested is described but there are minor omissions or vague details.
- 4) The hypothesis is clearly stated.

C2 Is able to design a reliable experiment that tests the hypothesis

- 1) The experiment does not test the hypothesis.
- 2) The experiment tests the hypothesis, but due to the nature of the design it is likely the data will lead to an incorrect judgment.
- 3) The experiment tests the hypothesis, but due to the nature of the design there is a moderate chance the data will lead to an inconclusive judgment.

- 4) The experiment tests the hypothesis and has a high likelihood of producing data that will lead to a conclusive judgment.

C3 Is able to distinguish between a hypothesis and a prediction

- 1) No prediction is made. The experiment is not treated as a testing experiment.
- 2) A prediction is made but it is identical to the hypothesis.
- 3) A prediction is made and is distinct from the hypothesis but does not describe the outcome of the designed experiment.
- 4) A prediction is made, is distinct from the hypothesis, and describes the outcome of the designed experiment

C4 Is able to make a reasonable prediction based on a hypothesis

- 1) No attempt to make a prediction is made.
- 2) A prediction is made that is distinct from the hypothesis but is not based on it.
- 3) A prediction is made that follows from the hypothesis but does not incorporate assumptions
- 4) A correct prediction is made that follows from the hypothesis and incorporates assumptions.

C5 Is able to identify the assumptions made in making the prediction

- 1) No attempt is made to identify any assumptions.
- 2) An attempt is made to identify assumptions, but the assumptions are irrelevant or are confused with the hypothesis.

- 3) Relevant assumptions are identified but are not significant for making the prediction.
- 4) All assumptions are correctly identified.

C6 Is able to determine specifically the way in which assumptions might affect the prediction

- 1) No attempt is made to determine the effects of assumptions.
- 2) The effects of assumptions are mentioned but are described vaguely.
- 3) The effects of assumptions are determined, but no attempt is made to validate them.
- 4) The effects of the assumptions are determined and the assumptions are validated.

C7 Is able to decide whether the prediction and the outcome agree/disagree

- 1) No mention of whether the prediction and outcome agree/disagree.
- 2) A decision about the agreement/disagreement is made but is not consistent with the outcome of the experiment.
- 3) A reasonable decision about the agreement/disagreement is made but experimental uncertainty is not taken into account.
- 4) A reasonable decision about the agreement/disagreement is made and experimental uncertainty is taken into account.

C8 Is able to make a reasonable judgment about the hypothesis

- 1) No judgment is made about the hypothesis.
- 2) A judgment is made but is not consistent with the outcome of the experiment.
- 3) A judgment is made and is consistent with the outcome of the experiment but assumptions are not taken into account.

- 4) A reasonable judgment is made and assumptions are taken into account.

C9 Is able to revise the hypothesis when necessary

- 1) A revision is necessary but none is made.
- 2) A revision is made but the new hypothesis is not consistent with the results of the experiment.
- 3) A revision is made and is consistent with the results of the experiment but other relevant evidence is not taken into account.
- 4) A revision is made and is consistent with all relevant evidence.

C.4 Rubric D: Ability to design and conduct an application experiment

D1 Is able to identify the problem to be solved

- 1) No mention is made of the problem to be solved.
- 2) An attempt is made to identify the problem to be solved but it is described in a confusing manner.
- 3) The problem to be solved is described but there are minor omissions or vague details.
- 4) The problem to be solved is clearly stated.

D2 Is able to design a reliable experiment that solves the problem

- 1) The experiment does not solve the problem.
- 2) The experiment attempts to solve the problem but due to the nature of the design the data will not lead to a reliable solution.

- 3) The experiment attempts to solve the problem but due to the nature of the design there is a moderate chance the data will not lead to a reliable solution.
- 4) The experiment solves the problem and has a high likelihood of producing data that will lead to a reliable solution.

D3 Is able to use available equipment to make measurements

- 1) At least one of the chosen measurements cannot be made with the available equipment.
- 2) All of the chosen measurements can be made, but no details are given about how it is done.
- 3) All of the chosen measurements can be made, but the details about how they are done are vague or incomplete.
- 4) All of the chosen measurements can be made and all details about how they are done are provided and clear.

D4 Is able to make a judgment about the results of the experiment

- 1) No discussion is presented about the results of the experiment
- 2) A judgment is made about the results, but it is not reasonable or coherent.
- 3) An acceptable judgment is made about the result, but the reasoning is flawed or incomplete.
- 4) An acceptable judgment is made about the result, with clear reasoning. The effects of assumptions and experimental uncertainties are considered.

D5 Is able to evaluate the results by means of an independent method

- 1) No attempt is made to evaluate the consistency of the result using an independent method.
- 2) A second independent method is used to evaluate the results. However there is little or no discussion about the differences in the results due to the two methods.
- 3) A second independent method is used to evaluate the results. The results of the two methods are compared using experimental uncertainties. But there is little or no discussion of the possible reasons for the differences when the results are different.
- 4) A second independent method is used to evaluate the results and the evaluation is done with the experimental uncertainties. The discrepancy between the results of the two methods, and possible reasons are discussed.

D6 Is able to identify the shortcomings in an experimental design and suggest specific improvements

- 1) No attempt is made to identify any shortcomings of the experimental design.
- 2) An attempt is made to identify shortcomings, but they are described vaguely and no specific suggestions for improvements are made.
- 3) Some shortcomings are identified and some improvements are suggested, but not all aspects of the design are considered.
- 4) All major shortcomings of the experiment are identified and specific suggestions for improvement are made.

D7 Is able to choose a productive mathematical procedure for solving the experimental problem

- 1) Mathematical procedure is either missing, or the equations written down are irrelevant to the design.
- 2) A mathematical procedure is described, but is incorrect or incomplete, due to which the final answer cannot be calculated.
- 3) Correct and complete mathematical procedure is described but an error is made in the calculations.
- 4) Mathematical procedure is fully consistent with the design. All quantities are calculated correctly. Final answer is meaningful.

D8 Is able to identify the assumptions made in using the mathematical procedure

- 1) No attempt is made to identify any assumptions.
- 2) An attempt is made to identify assumptions, but the assumptions are irrelevant or incorrect for the situation.
- 3) Relevant assumptions are identified but are not significant for solving the problem.
- 4) All relevant assumptions are correctly identified.

D9 Is able to determine specifically the way in which assumptions might affect the results

- 1) No attempt is made to determine the effects of assumptions.
- 2) The effects of assumptions are mentioned but are described vaguely.
- 3) The effects of assumptions are determined, but no attempt is made to validate them.
- 4) The effects of the assumptions are determined and the assumptions are validated.

C.5 Rubric F: Ability to communicate scientific ideas

F1 Is able to communicate the details of an experimental procedure clearly and completely

- 1) Diagrams are missing and/or experimental procedure is missing or extremely vague.
- 2) Diagrams are present but unclear and/or experimental procedure is present but important details are missing.
- 3) Diagrams and/or experimental procedure are present but with minor omissions or vague details.
- 4) Diagrams and/or experimental procedure are clear and complete.

C.6 Rubric G: Ability to collect and analyze experimental data

G1 Is able to identify sources of experimental uncertainty

- 1) No attempt is made to identify experimental uncertainties.
- 2) An attempt is made to identify experimental uncertainties, but most are missing, described vaguely, or incorrect.
- 3) Most experimental uncertainties are correctly identified.
- 4) All experimental uncertainties are correctly identified.

G2 Is able to evaluate specifically how identified experimental uncertainties may affect the data

- 1) No attempt is made to evaluate experimental uncertainties.

- 2) An attempt is made to evaluate experimental uncertainties, but most are missing, described vaguely, or incorrect. Or only absolute uncertainties are mentioned. Or the final result does not take the uncertainty into the account.
- 3) The final result does take the identified uncertainties into account but is not correctly evaluated.
- 4) The experimental uncertainty of the final result is correctly evaluated.

G3 Is able to describe how to minimize experimental uncertainty and actually do it

- 1) No attempt is made to describe how to minimize experimental uncertainty and no attempt to minimize is present.
- 2) A description of how to minimize experimental uncertainty is present, but there is no attempt to actually minimize it.
- 3) An attempt is made to minimize the uncertainty in the final result is made but the method is not the most effective.
- 4) The uncertainty is minimized in an effective way.

G4 Is able to record and represent data in a meaningful way

- 1) Data are either absent or incomprehensible.
- 2) Some important data are absent or incomprehensible.
- 3) All important data are present, but recorded in a way that requires some effort to comprehend.
- 4) All important data are present, organized, and recorded clearly.

G5 Is able to analyze data appropriately

- 1) No attempt is made to analyze the data.
- 2) An attempt is made to analyze the data, but it is either seriously flawed or inappropriate.
- 3) The analysis is appropriate but it contains minor errors or omissions.
- 4) The analysis is appropriate, complete, and correct.

C.7 Rubric H: Ability to engage in divergent thinking

H1 Is able to suggest multiple experiments to accomplish the desired goals

- 1) No attempt is made to suggest multiple experiments.
- 2) Multiple experiments are suggested but they are not appropriate.
- 3) Multiple experiments are suggested and they are appropriate, but are described vaguely or incompletely.
- 4) Multiple experiments are suggested and are described clearly.

H2 Is able to suggest experiments from diverse contexts to accomplish the desired goals

- 1) No attempt is made to suggest experiments from different contexts.
- 2) Multiple experiments are suggested but they are essentially from the same context.
- 3) Experiments are suggested from multiple contexts and they are appropriate, but are described vaguely or incompletely.
- 4) Experiments are suggested from multiple contexts and they are described clearly.

H3 Is able to identify positive and negative features in a set of potential experiments and choose which experiment(s) is most likely to accomplish the desired goals

- 1) No attempt is made to identify positive and negative features. An experiment(s) is chosen arbitrarily.
- 2) Some features are identified but they are not used in choosing an experiment(s).
- 3) Most features are identified and used in choosing an experiment(s), but the reasoning is flawed.
- 4) Positive and negative features of each experiment are identified and a reasonable experiment(s) is chosen.

H4 Is able to think and evaluate different possibilities when solving a problem

- 1) No evidence that different possibilities have been considered.
- 2) Different possibilities have been mentioned but not discussed in detail.
- 3) Different possibilities have been analyzed, one considered and possibility was chosen but the choice was not justified or the justification is flawed.
- 4) Different possibilities have been considered, analyzed, and the one has been chosen.
The decision is clearly supported by correct reasoning.

C.8 Rubric I: Ability to evaluate models, equations, solutions, and claims

II Is able to conduct a unit analysis to test the self-consistency of an equation

- 1) No meaningful attempt is made to identify the units of each quantity in an equation.
- 2) An attempt is made to identify the units of each quantity, but the student does not compare the units of each term to test for self-consistency of the equation.

- 3) An attempt is made to check the units of each term in the equation, but the student either misremembered a quantity's unit, and/or made an algebraic error in the analysis.
- 4) The student correctly conducts a unit analysis to test the self-consistency of the equation.

I2 Is able to analyze a relevant special case for a given model, equation, or claim.

- 1) No meaningful attempt is made to analyze a relevant special case.
- 2) An attempt is made to analyze a special case, but the identified special case is not relevant. OR major steps are missing from the analysis (e.g., no conclusion is made)
- 3) An attempt is made to analyze a relevant special case, but the student's analysis is flawed. OR the student's judgment is inconsistent with their analysis.
- 4) A relevant special case is correctly analyzed and a proper judgment is made.

I3 Is able to identify the assumptions a model, equation, or claim relies upon.

- 1) No assumptions are correctly identified.
- 2) Some assumptions are correctly identified by student, but some of the identified assumptions are incorrect.
- 3) All of the student's identified assumptions are correct, but some important assumptions are not identified by student.
- 4) All significant assumptions are identified, and no correctly identified assumptions are incorrect.

14 Is able to evaluate another person's problem solution or conceptual claim by direct comparison with his or her own solution or conceptual understanding

- 1) No meaningful attempt is made to evaluate by direct comparison.
- 2) The student states his/her own problem solution/conceptual claim, but does not methodically compare it with the other person's solution/claim, and so does not state a judgment about the validity of the other person's solution/claim. OR a judgment is made regarding the other person's solution/claim, but no justification is given.
- 3) The student states his or her own solution/claim and compares it with the other person's solution/claim, but does not make any concluding judgment based on this comparison. OR the student does everything correctly, but their presentation is incomplete (i.e., skipping logical steps)
- 4) Student clearly states his or her own solution/conceptual understanding, and methodically compares it with the other person's work. Based on this comparison, the student makes a sound judgment about the validity of the other person's work.

15 Is able to use a unit analysis to correct an equation that is not self-consistent

- 1) No meaningful attempt is made to correct the equation, even though it failed a unit analysis
- 2) Student proposes a corrected equation, but their proposal still does not pass a unit analysis
- 3) Student proposes a corrected equation which passes unit analysis, but their proposal is incorrect (i.e., the student failed to remember the proper equation, and therefore proposed an equation which is not physical)

- 4) Student proposes a corrected equation that is correct, at least up to unit-less constants.

16 Is able to use a special-case analysis to correct a model, equation, or claim

- 1) No meaningful attempt is made to correct the model, equation, or claim even though it failed a special-case analysis
- 2) An attempt is made to modify the model, equation, or claim, but the modifications have nothing to do with the special-case that was analyzed.
- 3) An attempt is made to modify the model, equation, or claim based on the special-case analysis, but some mistakes are made in the modification.
- 4) The model, equation, or claim is correctly modified in accordance with the special-case that was analyzed.

Ability to evaluate models, equations, solutions, and claims

17 Is able to identify an optimally relevant special-case for analysis

- 1) No attempt is made to identify a relevant special case
- 2) An attempt is made, but the identified special case is either irrelevant or ill-defined
- 3) A relevant special case is identified, but it is not an optimal special case (i.e., there are other special cases which give a stronger, more clear-cut analysis of the solution)
- 4) A optimally relevant special case is identified and clearly stated

18 Is able to state and justify a conceptual expectation for the special case

- 1) No attempt is made to state or justify a conceptual expectation

- 2) A conceptual expectation is stated, but its justification is either absent or missing major steps
- 3) A conceptual expectation is stated, but its justification is either missing minor steps, or is inconsistent with the expectation
- 4) A conceptual expectation is stated, fully justified, and the expectation is consistent with its justification

I9 Is able to use a given solution (or a solution they made up) to predict what would happen for the special case

- 1) No attempt is made to state or explain what the given solution predicts for the special case
- 2) A prediction is stated, but its derivation from the given solution is either absent or missing major steps
- 3) A predication is stated, but its derivation from the given solution is either missing minor steps, or is inconsistent with the derivation
- 4) A prediction is stated and clearly derived from the given solution

I10 Is able to make, and justify, a reasonable conclusion regarding their conceptual expectation and the solution.

- 1) No attempt is made to state or justify a conclusion
- 2) A conclusion is stated, but its justification is either absent, missing major steps, or containing major mistakes

- 3) A conclusion is stated and justified, but it is inconsistent with the results of the student's analysis, or it is incomplete
- 4) A conclusion is stated and justified, and is consistent with the results of the student's analysis.